

User Manual

CIOT-700M



- Thank you for purchasing COMMAX products.
- Please carefully read this User's Guide (in particular, precautions for safety) before using a product and follow instructions to use a product exactly.
- The company is not responsible for any safety accidents caused by abnormal operation of the product.

Contents

Warnings and caution	2
1. Main function	4
2. Home Screen	10
2.1 Editing a space list	11
2.2 Registering a device	12
2.3 Placing device (move / delete)	15
2.4 Controlling devices	18
2.5 Widget Area	18
3 House Reporter	20
3.1 Edit house reporter	20
3.2 Setting the weather area	20
4. Control	22
4.1 Control lighting	22
4.2 Multi-sensor	23
4.3 Magnetic sensor	23
4.4 Adding devices	24
4.5 Edit device	25
5. Application	26
5.1 Interphone	26
5.2 Door entrance	27
5.3 Call Log	29
5.4 Security	31
5.5 Checking visitor	34
5.6 Etc App	36
5.7 Wallpad setting	39
6. Scene / Booking control	50

Safety Warning & Caution

Please follow the things described below in order to prevent any danger or property damage.

	<p>Warning It may cause a serious damage or injury if violated.</p>		<p>Prohibition.</p>
	<p>Caution It may cause a minor damage or injury if violated.</p>		<p>No disassembly</p>
			<p>No touch</p>
			<p>Must follow strictly.</p>
			<p>Shows plugging out the power cord without an exception</p>
			<p>Shows the warning and caution for an electric shock.</p>
			<p>Shows the warning and caution for a fire.</p>

Warning

Power & Installation

Please don't use several products at the same time on one power socket.

- It may cause a fire due to an abnormal overheating.

Prohibition Fire

Please don't bend the power cable excessively or it may cause an electric shock.

- fire when using a damaged power cable.

Prohibition Electric shock Fire

Please don't handle the power cable with a wet hand.

- It may cause an electric shock.

Prohibition Fire

Please plug out the power cable from the socket when not using it for a long period of time.

- It may shorten the product lifespan or cause a fire.

Request Fire

Please don't install the product in the place where there is much oil, smoke or humidity.

- It may cause an electric shock or fire.

Prohibition Electric shock Fire

Please don't install the product with the lightning and thunder.

- It may cause an electric shock or fire.

Prohibition Electric shock Fire

Please don't use and connect this product with other products with different rated voltage

- It may cause a disorder or fire.

Prohibition Fire

When installing the product that generates heat, please install the product away from the wall (10cm) for the ventilation.

- It may cause a fire due to the increased internal temperature.

Prohibition Fire

Warning

Cleaning & Use

Please don't disassemble, repair or rebuild this product arbitrarily (please contact the service center if a repair is needed).

- It may cause an electric shock or fire.

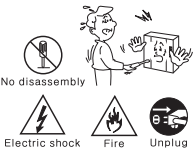

If an abnormal sound, burning smell or smoke is coming out of the product, please plug out the power cable and contact a service center.

- It may cause an electric shock or fire.

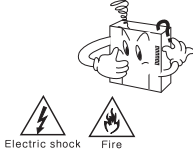

Please don't insert any metallic or burnable materials into the ventilation hole.

- It may cause an electric shock or fire.

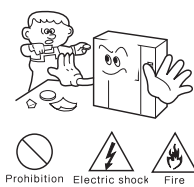

Please use only the designated batteries for the products of using DC power.

- It may cause an electric shock or fire.

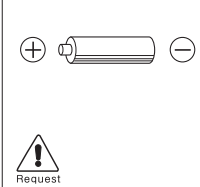

Caution

Power & Installation

Please plug the power cable firmly into the inner end

- It may cause a fire.

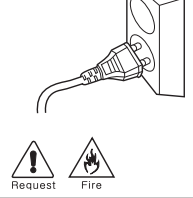

Please hold the plug tightly when unplugging the power cable (a part of the copper wire may be disconnected if the grabbing is only made on the cord when pulling out the cable).

- It may cause an electric shock or fire

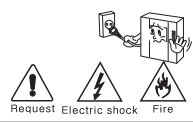

When connecting the power cables after cutting the cable, please install the product with power off

- It may cause an electric shock or fire

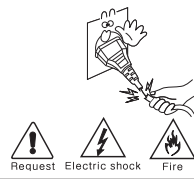

When installing the product, please fix it firmly while using the wall-mounting unit and screws.

- It may cause an injury from the falling object.

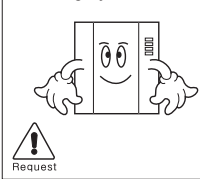

Please be careful when using an AC circuit breaker since there is a possibility of an electric shock.

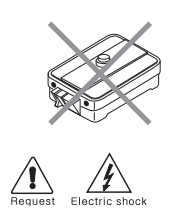

Please check the use voltage and current for the DC-only products and use the appropriate rectifier.

- It may cause a fire.



Please avoid direct rays of the sun or heating devices at a time of installation.

- It may cause a fire.



Please don't install the product on an unstable place or small support board.

- It may cause an injury if it falls down while in use.

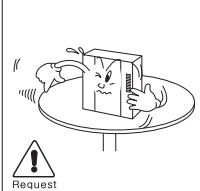

Cleaning & Use

When cleaning the product, please rub it with a soft and dry cloth after plugging out the power cable. (Please don't use any chemical products such as wax, benzene, alcohol or cleanser.)



Please don't drop the product on the ground and don't apply a shock.

- It may cause a failure.



Please use the designated connection cable within the maximum calling distance designated for the product

- It may reduce the product performance.

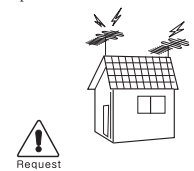

Start

1 Main function

Function	Description
COMMAX Widget	Display of widget type such as today's weather, indoor temperature and humidity, smart plug electricity amount, absence information
Login and Membership	User subscription and login to use UC and Cloud
My Reporter	To view and set the integrated value information provided by the app
COMMAX launcher	Support for space control / editing / addition to the main screen and main functions (weather, quick menu, household device information, individual device control)
Scene control	It is main functions that can display basic values (away, burglar), appear user-specified scenes, and register new scenes and delete
My house coach	Offer various lifestyle tips to users by apps
Device control	Function to control a wireless device that works with wall-pad
Apps	Show all apps that are registered in the wall-pad
Door call / recording	Video call with IP door and recording function through IP network
House to call	Call between household and another household through IP network
Lobby call / recording	Video call to lobby and recording function by IP network
Guard call	Voice call to guard station by IP network
Call list	Checking the call list and recorded video of lobby phone and IP Door

CCTVlive view/ recording	Real-time and CCTV video monitoring service Fuction to display and record multiple images on two or more monitors
CCTV video recording view	Check recorded CCTV images by date
Security fuction	Using wireless IoT sensor (magnetic, PIR) to away, burglar, emergency handling
Scenario Control	Multi-control function for device by user condition
System management	Manual setting of the basic environment (IP setting, etc.) by the user
Automatic device registratation	User can register interlock device (IP Door, CCTV, IoT device, etc.)
COMMAX Setting	IP and various enviroence setting for lobby call and system operation
Mobile call	Calls to mobile phones login ID same as wallpad
Video streaming server	Format reset function to send CCTV / Door image to external (UC)
Cloud server	Wall pad control by smartphone through cloud server
Notification	Fuction to notify emergency from your house to mobile phone

- Interlocked mobile phone

(Smart devices are compatible with Android OS (4.4.1 or later), iOS (8.0 or later)

OS	Resolution	Mobile phone
Apple	1136x640	iPhone5s
	1920x1080	iPhone6
	1334x750	iPhone6s
	1920x1080	iPhone6 Plus
	1334x750	iPhone7

Android	1920x1080	Nexus5x
	2048x1536	Nexus9
	2560x1440	Galaxy Note 4
	2560x1440	GalaxyS5 edge
	1920x1080	GalaxyS4
	2560 x 1440	LG G3 cat6
Total		11ea



● CIOT-700M

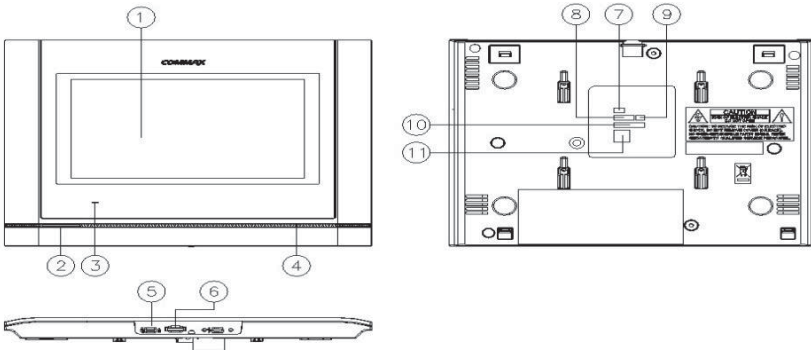

No.	CONTENTS	No.	CONTENTS
1	Touch screen	6	T-FLASH
2	SPEAKER	7~10	Not Use
3	POWER LED	11	POE-(LAN)
4	MIC		
5	POWER S/W		

Basic Screen Configuration

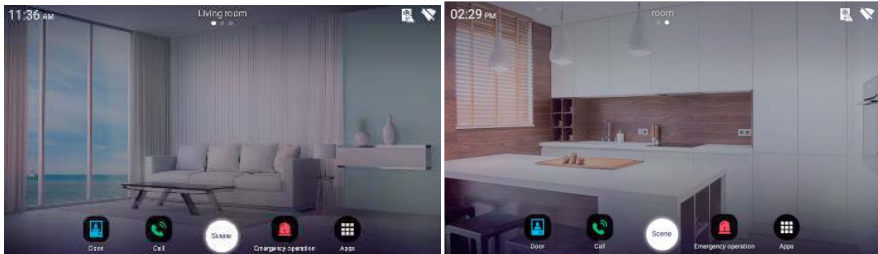

The moving of screen for using scrolling

The screen change

The navigation bar of home screen bottom

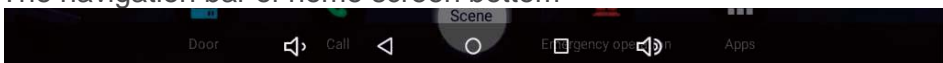







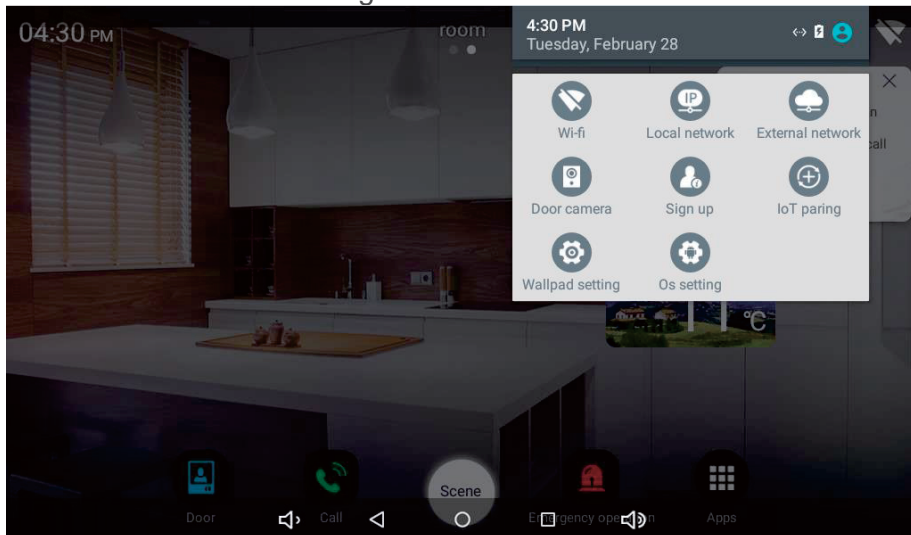

	Go to home screen		Go back
	Volume control		

Go to Setting

Home screen bottom setting bar







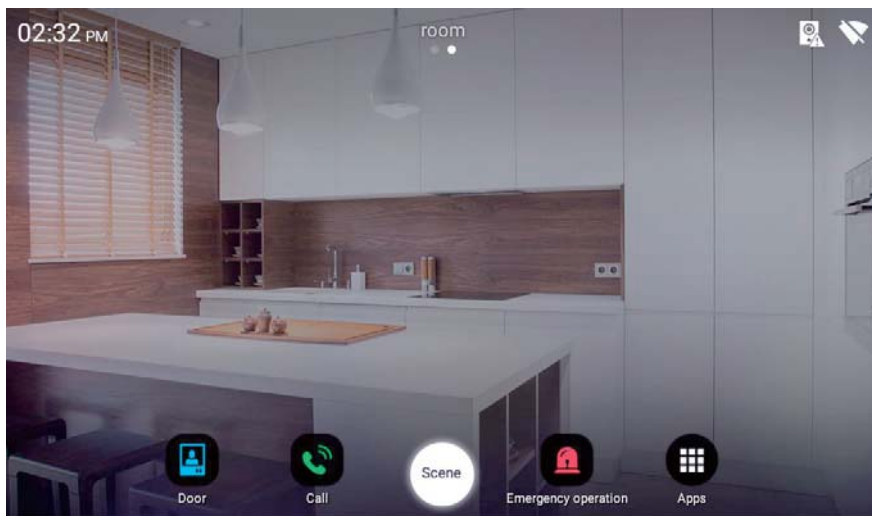

 Wi-fi	Wifi setting	Go to system wireless Wifi setting
 Local network	IPsetting	Go to wired network IP setting
 External network	Internet status	Check the status of external Internet connection
 Door camera registration	Door	Go to IP Door Camera registration

 Sign up registration	User	Go to user registration
 IoT pairing registration	IoT Device	Go to IoTt device registration
 Wallpad setting settings	Wall pad	Go to wall pad setting
 Os setting	OS setting	Go to OS setting

2 Home Screen

Home Area

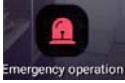

 Door	View the door camera	View the door camera
 Call	dial	Dial key for call
 Device status	Device	Door, network, membership status display * Icons is displayed during abnormal operation
 all Apps		All App list
 Scene	Scene contorl	Scene and Reservation control
 Emergency operation Emergency button		User Emergency button

2.1. Editing a space list

- 1) 'Press an empty space on background screen for one second.

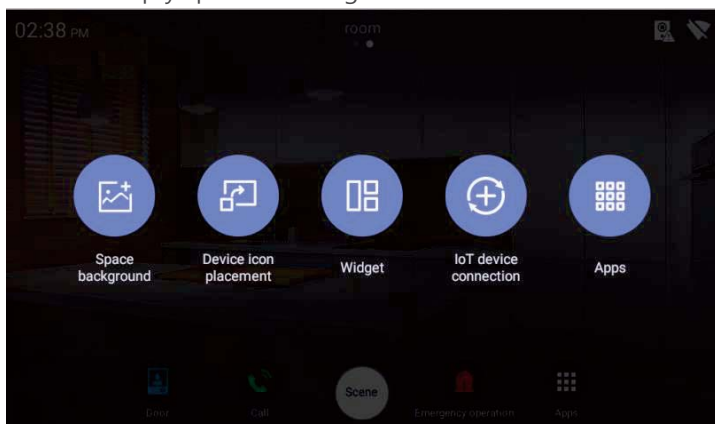

- 2) Drag the space you want to move and move it to the desired location
- 3) Press the "X" button to delete the space.
- 4) Press "+" button to add space
- 5) Press the Cancel button to cancel editing.
- 6) Press the 'complete ' button to save the space list.

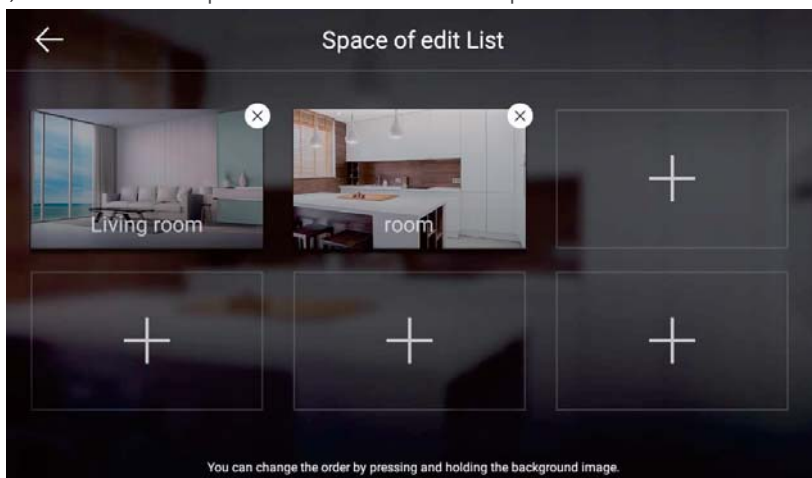

Adding Space

- 1) Enter the name of the space.

- 2) Press "Enter" on the keyboard.
- 3) Select a space image .
- 4) ✓ 'Press 'OK' button to add space.
- 5) ← 'Previous' button will move to previous screen

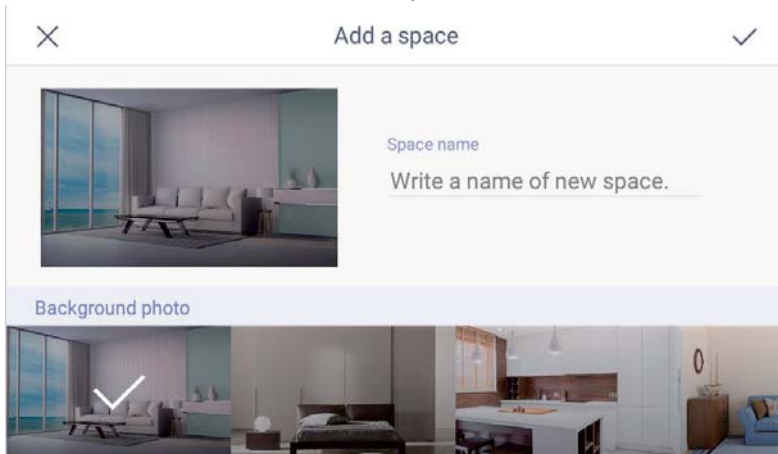

2.2. Registering a device

Method 1.

- 1) Press an empty space on background screen for one second.

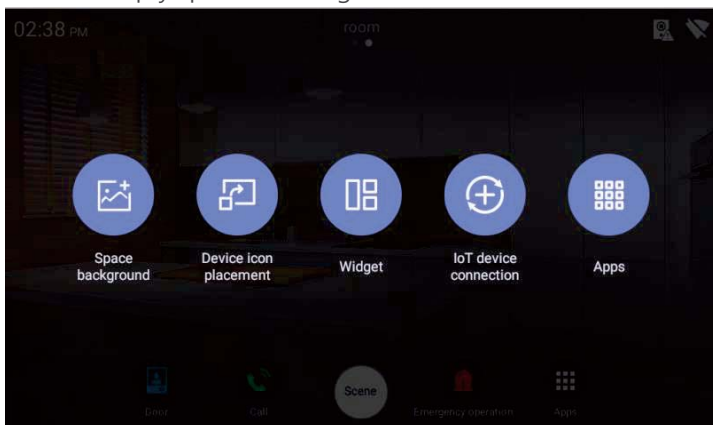

- 2) Press register IoT Device

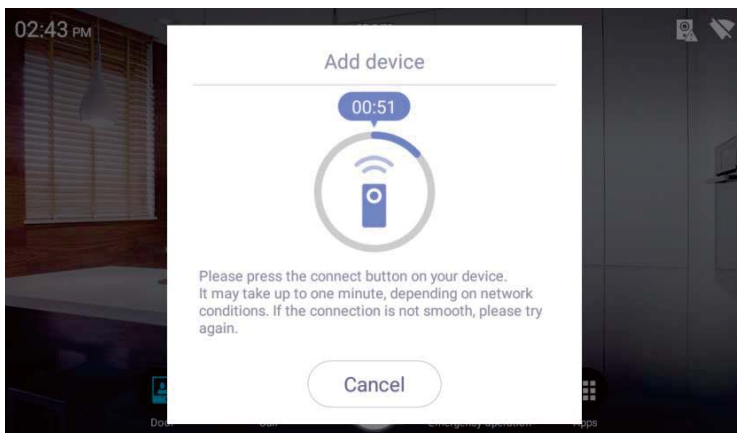

- 3) Connect the device according to the device pairing method..
- 4) The device can be paired for up to 60 seconds.
- 5) Press Cancel 'button to cancel the device pairing method.
- 6) When a device is registered, the device is automatically placed on the screen

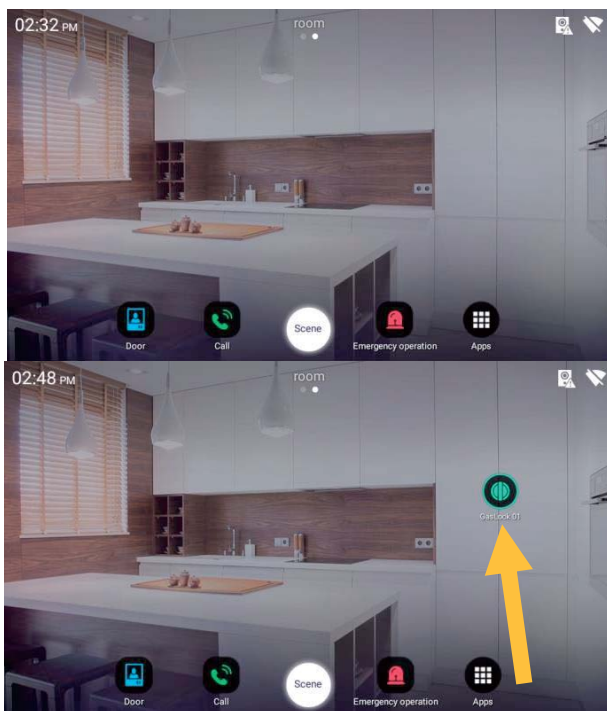

Method 2.

- 1) Drag or click IoT Device ICON leftside on screen

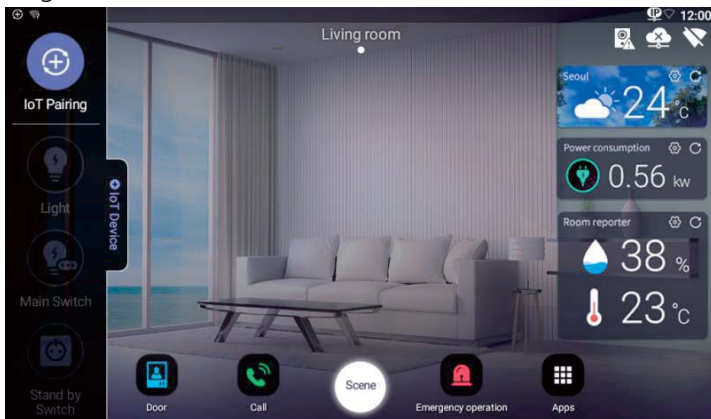

- 2) Click IoT Pairing ICON on upside and drag center on screen.

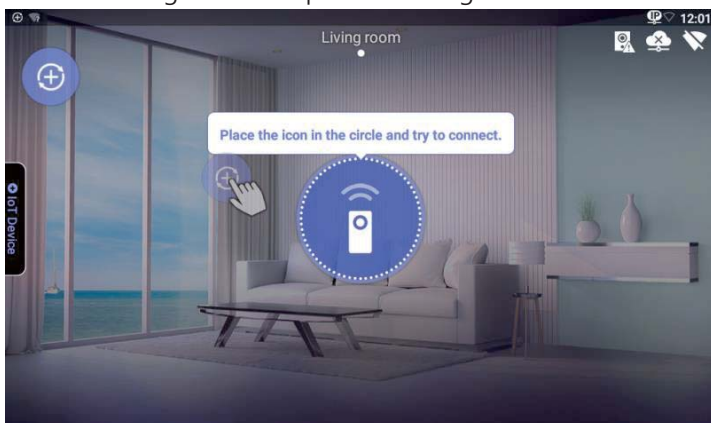

- 3) Connect the device by using device pairing method.

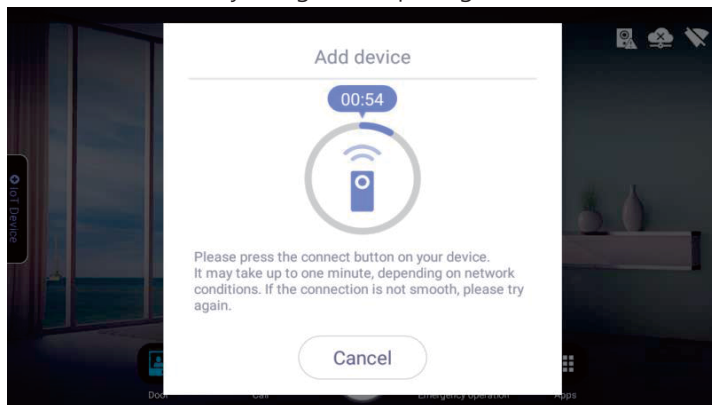

2.3. Placing device (move / delete)

Method1.

- 1) Press an empty space on background screen for one second

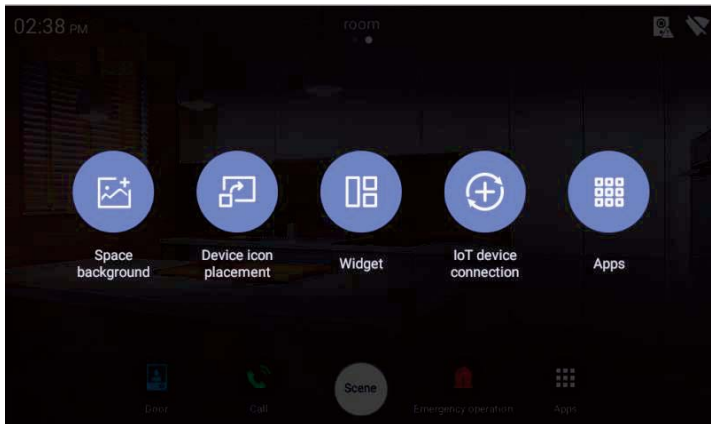

- 2) Press 'Device icon placement'.
- 3) You can move to the desired location by pressing the device you want to move.

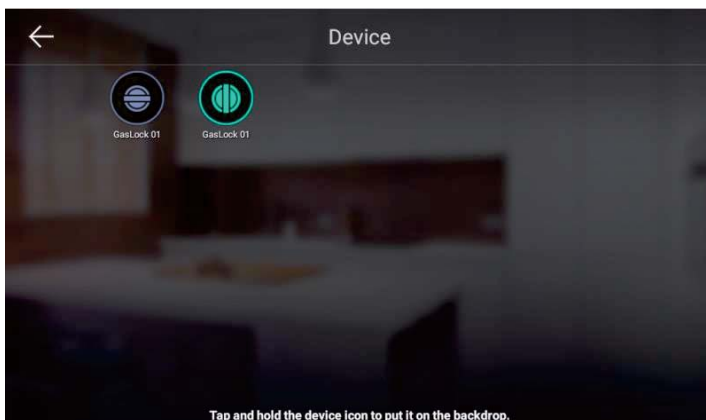

- 4) Drag the device, move it to the desired location, and release the device
- 5) To delete a device, press the corresponding icon longer to move to the desired location..

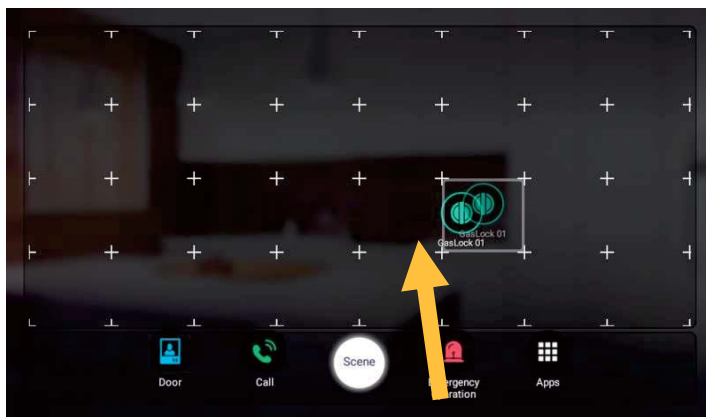

6) To delete a device, press the icon longer and move it to the upper trash...

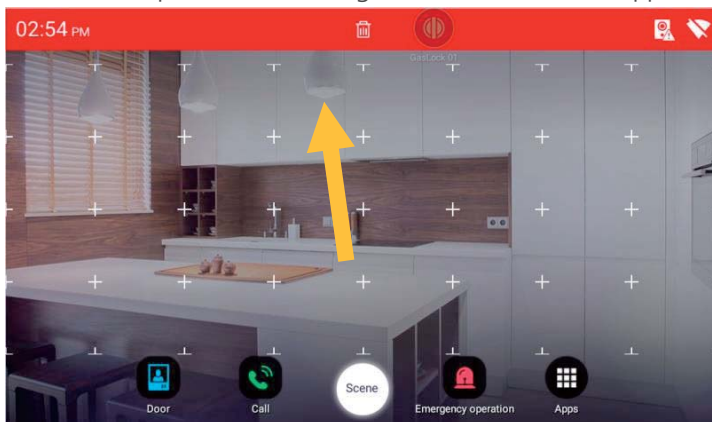

[Device delet screen]

Method 2.

1) Drag or click IoT Device ICON leftside on screen

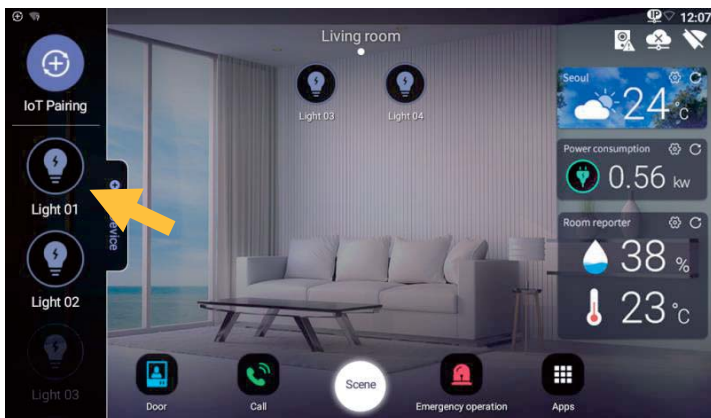

- 1) You can move to the desired location by pressing the device you want to move.

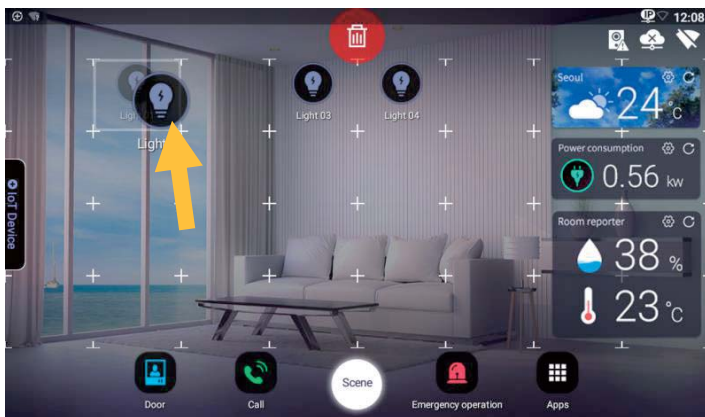

- 2) To delete a device, press the icon longer and move it to the upper trash...

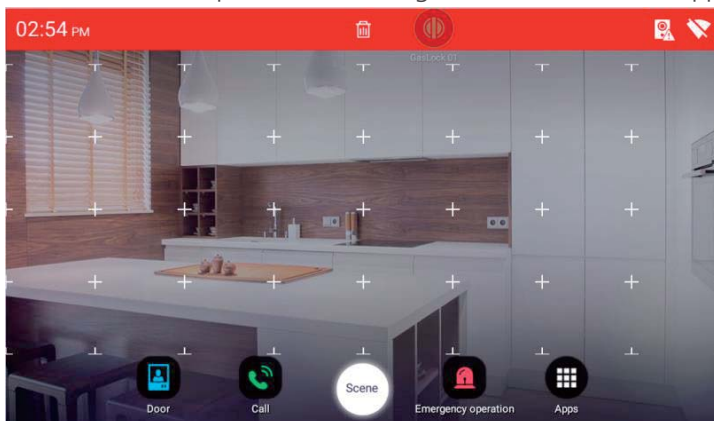

2.4. Controlling devices

- 1) Move to the space to control.
- 2) You can turn the device on / off by pressing the device you want to control..

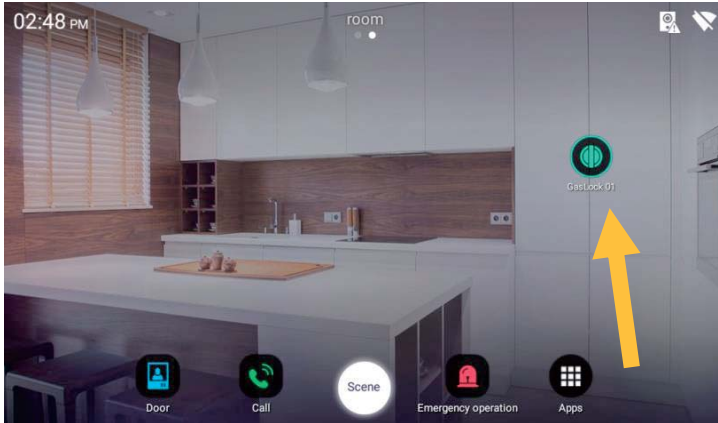

[The device control screen]

2.5. Widget Area

- 1) Provide a summary of our home environment and external environment information at present..
- 2) Press empty space on background screen for one second.

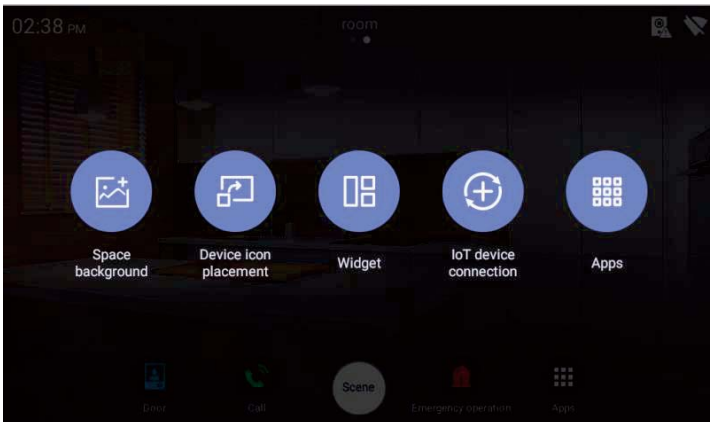

- 3) Press widget .
- 4) Select and drag the widget you want to display on the background

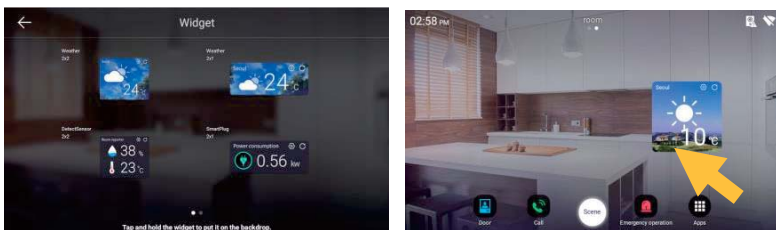

- 5) To delete a widget, press the widget longer and move it to the upper trash.

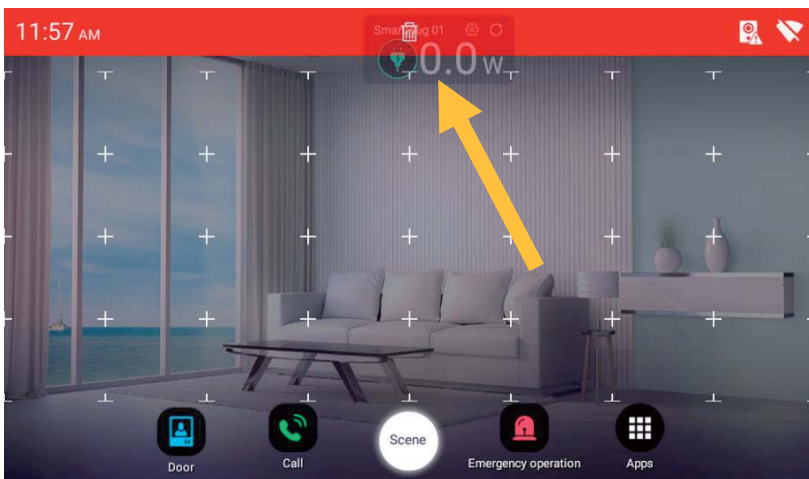



3 House Reporter

We provide value information on the screen that allows us to understand our home environment and external conditions..



[The house reporter screen]

3.1. Edit house reporter

- 1)  Press edit "buttonu"
- 2)  Press the "(On / Off)" button and you can select the value information item to be displayed..
- 3)  OK "button to save the changed item.



[The house report edit screen]

3.2. Setting the weather area

- 1) 'Press the "Today's weather information" button.
- 2) Enter the name of the area to search.
- 3) Press the "Search" button..
- 4) Select one of areas from search list .

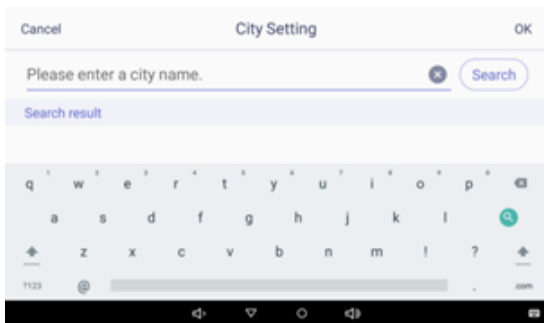

[The weather area setting screen]

4 Control

4.1. Control lighting

- 1) Go to the Lighting tab.
- 2) When you press power button of whole lightings, all lightings are turned on.
- 3) When you press power button of whole lightings, all lightings are turned off.
- 4) Press the power button of the lighting you want to control to turn the light on or off.

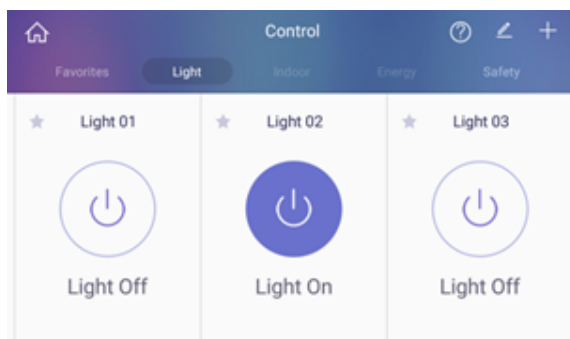

[Lighting Control Screen]

4.2. Multi-sensor

Checking multi-sensor

- 1) Go to the Indoor Environment tab.
- 2) Displays information collected in indoor environment by multi-sensor.

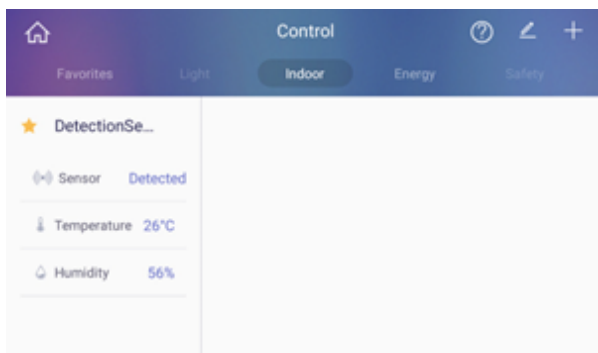

[Multi sensor Screen]

4.3. Magnetic sensor

- 1) Go to the Safety tab.
- 2) 'Detected' is displayed when door open is detected.
- 3) If no door open is detected, "No detected" is displayed.

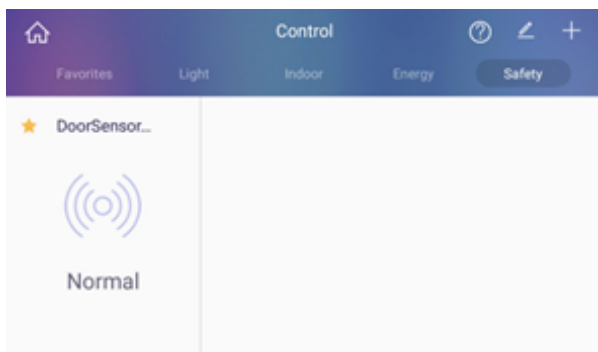

[Magnetic sensor Screen]

4.4. Adding devices

Control standby power

- ① Press the + button to enter the Add Device mode.
- ② Pairing mode is for 1 minute .

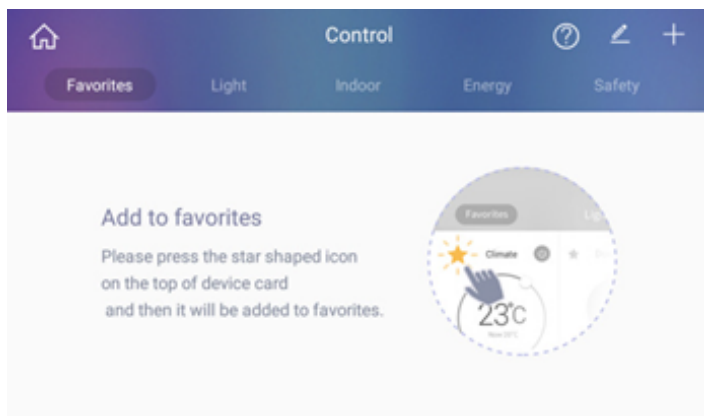

[Standby power Screen]

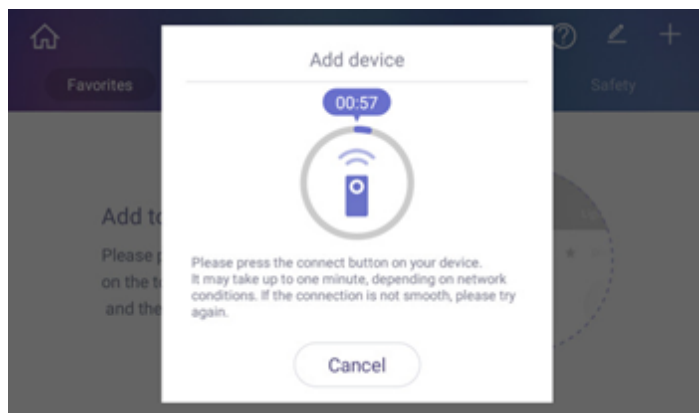

[Standby power Screen]

4.5. Edit device

Change the device nickname

- 1) Select the device and change the nickname.
- ① Press button and finish changing the nickname of the devices.

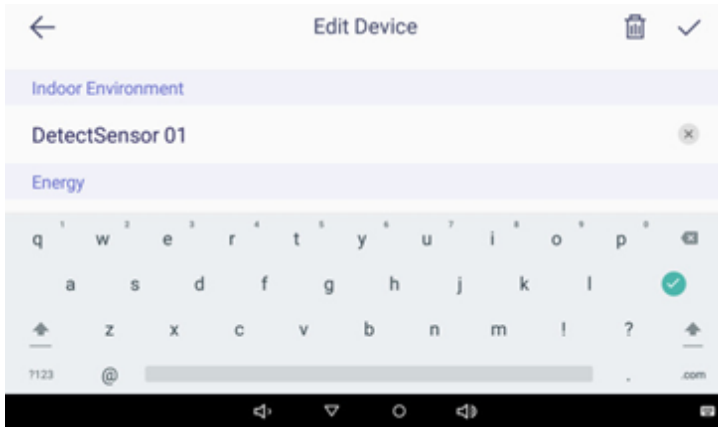

[Device edit Screen]

Remove device

- 1) Select the device you want to delete.
- 2) Press the ① button to complete the deletion of the devices.



[Remove device Screen]

5 Application

5.1. Interphone

5.1.1. Screen Layout

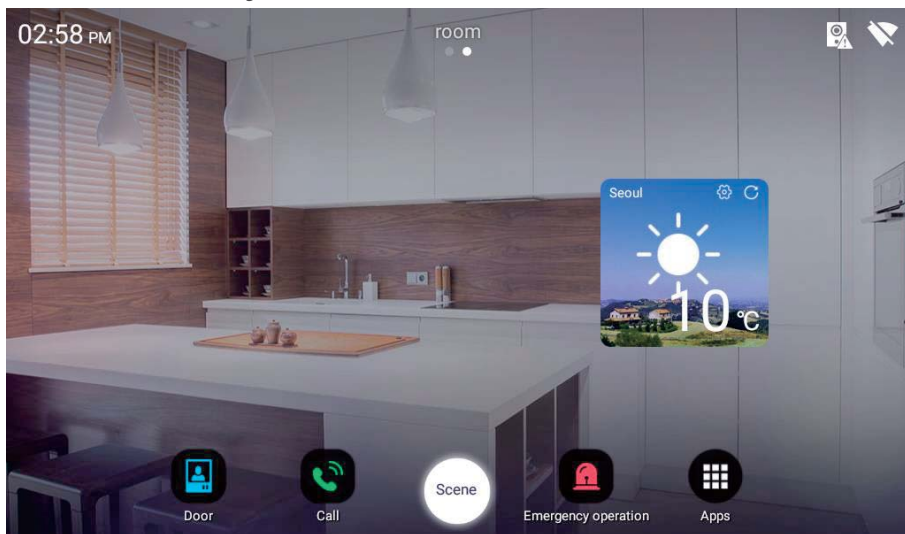

Call connection screen

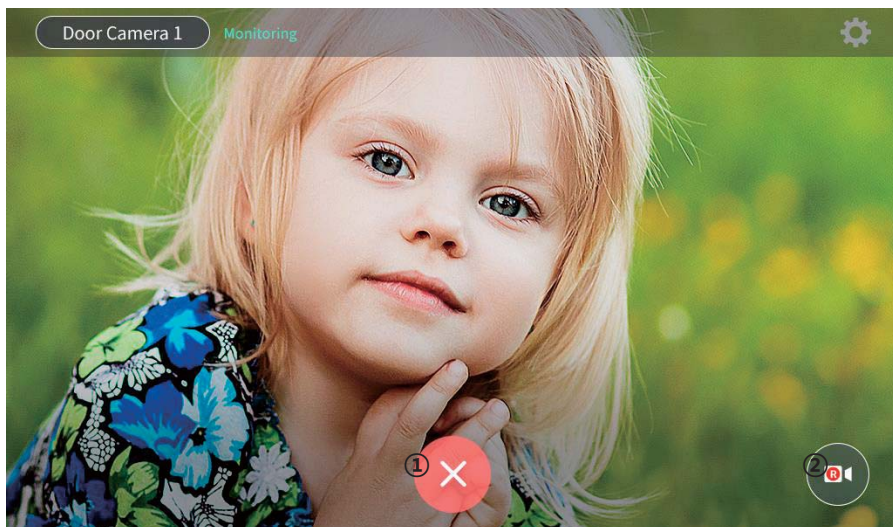

[Monitoring Screen]

- 1) Press ① button to end the door monitoring.
- 2) Press ② button to save video.

Call connection screen

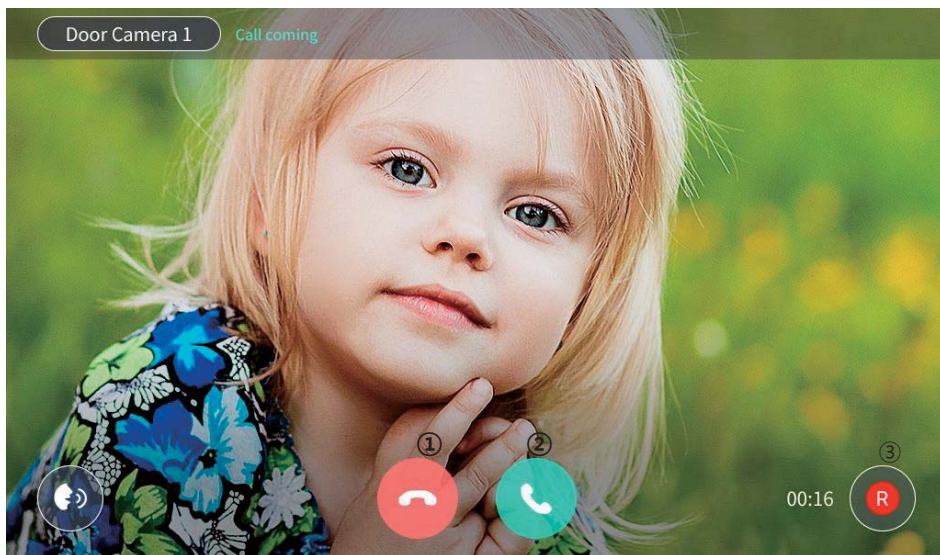

[Call connection Screen]

- 1) ① End call.
- 2) ② Start Call / Open Door
- 3) ③ Save video
- 4) ④ Adjust call volume

5.2. Door entrance

Monitor and call from door camera

- 1) Click on the door entrance icon in the Quick Menu.
- 2) You can monitor the door entrance by pressing the 'door entrance' button.
- 3) To cancel monitoring, click the 'Cancel' button.
- 4) When you press the bell on the door camera, the call screen appears..
- 5) To end the call, press the "End call" button.

Open the door

- 1) When the call comes in and the call button is pressed, the door open button appears.
- 2) Press the door open button to open the door.

Saving the image of our house / common entrance visitor

- 1) When you press the save video button during a call, the icon changes to  and video recording starts.
- 2) Once you click the save button again, the image will be saved.

Get a call on door camera

- 1) When you receive a call, the bell sound and visitor screen are displayed on the screen.
- 2) Press the (Talk) button to connect the call and press the "Reject" button to hang up.
- 3) To stop during a call, press the "Exit" button.
- 4) If you receive calls from two or more during the call, the screen will appear on the upper left corner and you will be connected immediately when you click on the screen..

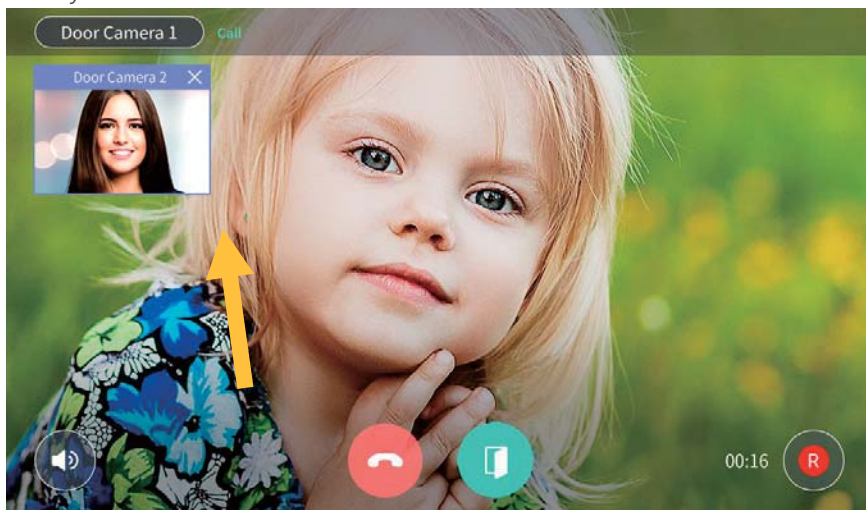

Call house

- 1) Press dial on background .
- 2) You can call by entering the number of building and household or pressing the button of guard station and office

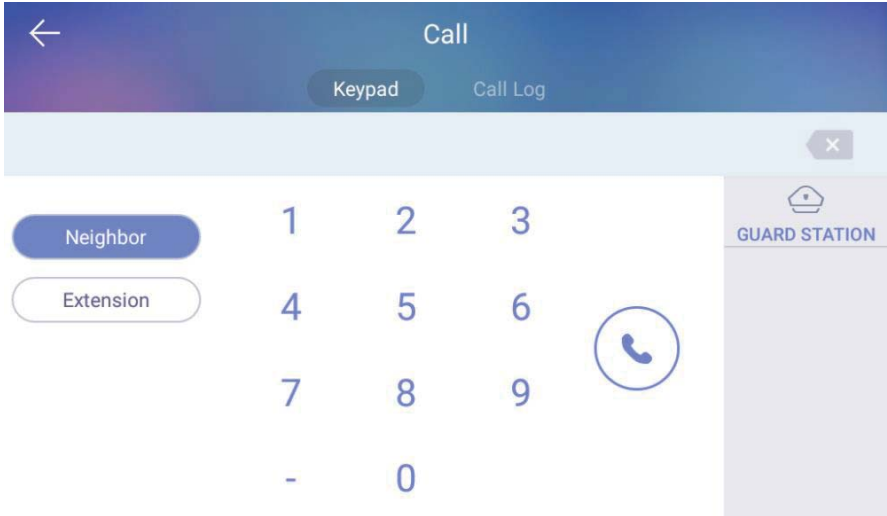

5.3. Call Log

The last 7 days		
	Door Camera	2017/01/02
	Door Camera	2017/01/02
	Door Camera	2017/01/02
	Door Camera	2017/01/02
	Door Camera	2017/01/02



[Display for Call log]

Using Call Log



- 1) When you click  icon at the top of screen, you can delete the call log.

5.4. Security

 CCTV monitoring	CCTV	CCTV monitoring and save the image
 Emergency operation emergency	Occur	Occur emergency on urgent situation

5.4.1. Security



Occur emergency
Detect emergency

The emergency has been activated by users or sensors automatically. Emergency situation will be operated with 3 steps(Occur → Stop → Restore).

5.4.2. Occur emergency

- 1) You can activated the emergency for clicking the emergency button. Also it can be operated by sensors automatically.
- 2) The siren will be activated and display the emergency icons.

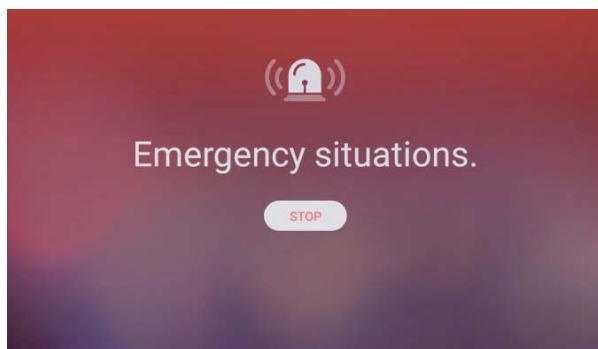

[display for emergency situation]

5.4.3. Stop emergency

- 1) Click the "Stop" button.
- 2) Click the password and "OK" button. (Password from factory : 1234)

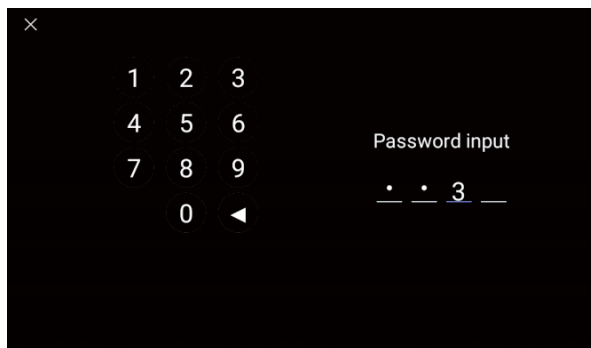

[Enter password]

5.4.4. Return emergency

- 1) Click the "Restore" button.
- 2) When you click it, the emergency will be disarmed.

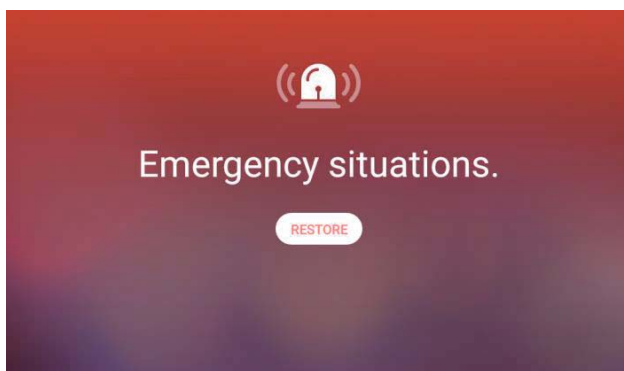

[Window for restoring emergency]

5.4.5. CCTV



- Check the display of CCTV
- Save the image of CCTV

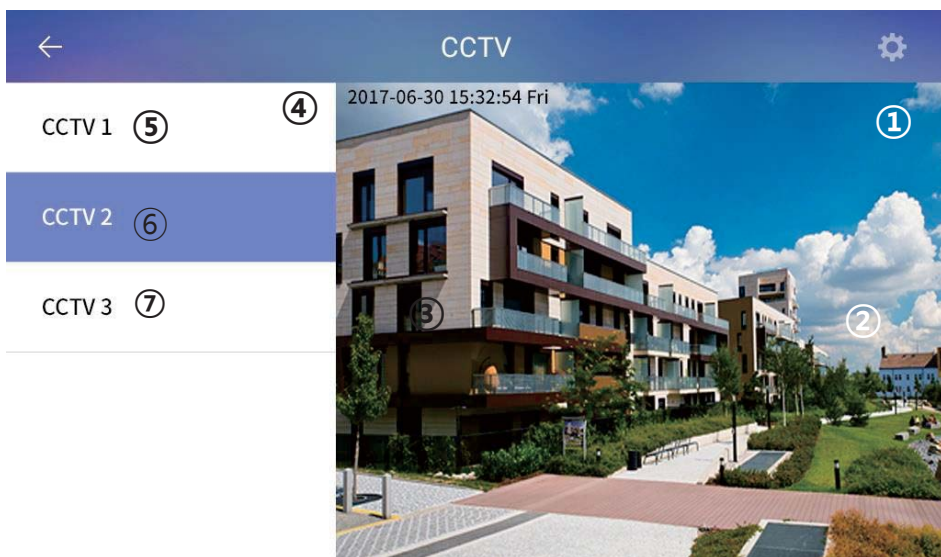

[CCTV menu display]

① CCTV Display	⑤ Favorites
② Move to the next display	⑥ Selected lists
③ Move to the previous display	⑦ List of favourites
④ Channel list	⑧ Check the saved image

CCTV monitoring & saving

- 1) Click the channel list(④) you can see the CCTV list(⑥) on the display.
- 2) Click the CCTV list, you can see the image of CCTV(①).
- 3) If you want to see the next CCTV, click the Next button(②).
- 4) If you want to see the previous CCTV, click the Next button(③).

Register, remove & check the favourites

- 1) Main display of CCTV, click the star icon next to the CCTV list, you can register or remove CCTV on the favorites list.
- 2) Click the list of favorites(⑤), you can check the favorited CCTV list on the display.
- 3) The star of CCTV list(⑦) is on, you can remove on the favorite list for clicking the star(⑦) on the list.

5.5. Checking visitor

 Visitor	Checking visitor	Check the saved image of entrance or lobby
--	------------------	--

5.5.1. Visitor



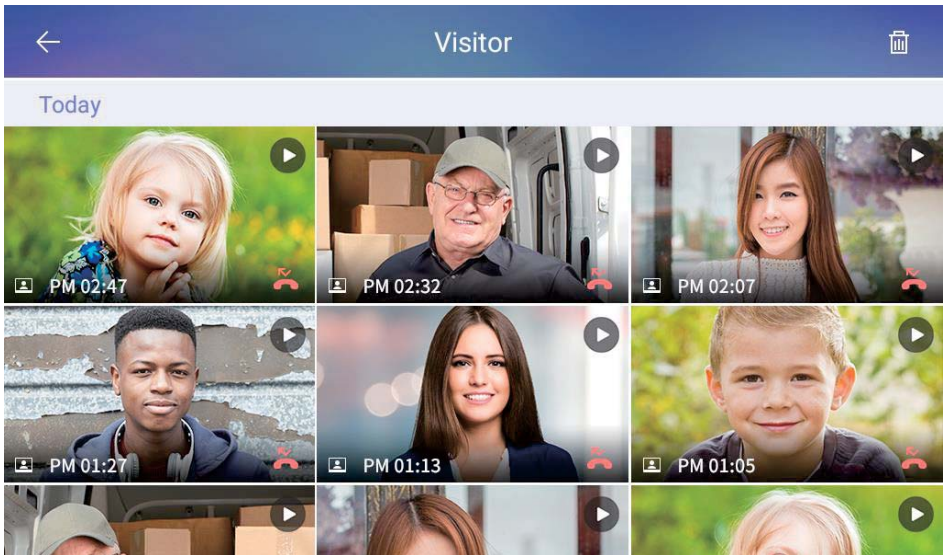

Check the saved image of entrance or lobby



[Display for saved image]

 Delete	Delete the saved image
--	------------------------

With icons, you can check the location of saved movie clip.

 Entrance	Movie clip from entrance
 Lobby	Movie clip from lobby
 Missed Call	Movie clip from missed call

Check the saved movie clip

You can check the time and date of saved movie clip from the entrance or lobby.







Delete the saved movie clip

- 1) Click the 'Delete' button.
- 2) Click the individual movie clip or "All movie clip" for the selection.
- 3) To un-select the movie clip, click that icon again.
- 4) Click "Delete" button to remove the movie clip.

5.5.2. Emergency log



Emergency log

← Emergency Log 	
 Emergency Restore	Tuesday, February 28, 2017, 3:18 PM
 Emergency Stop	Tuesday, February 28, 2017, 3:18 PM
 Emergency Occur	Tuesday, February 28, 2017, 3:17 PM
 Emergency Restore	Tuesday, February 28, 2017, 3:17 PM
 Emergency Stop	Tuesday, February 28, 2017, 3:17 PM
 Emergency Occur	Tuesday, February 28, 2017, 3:17 PM





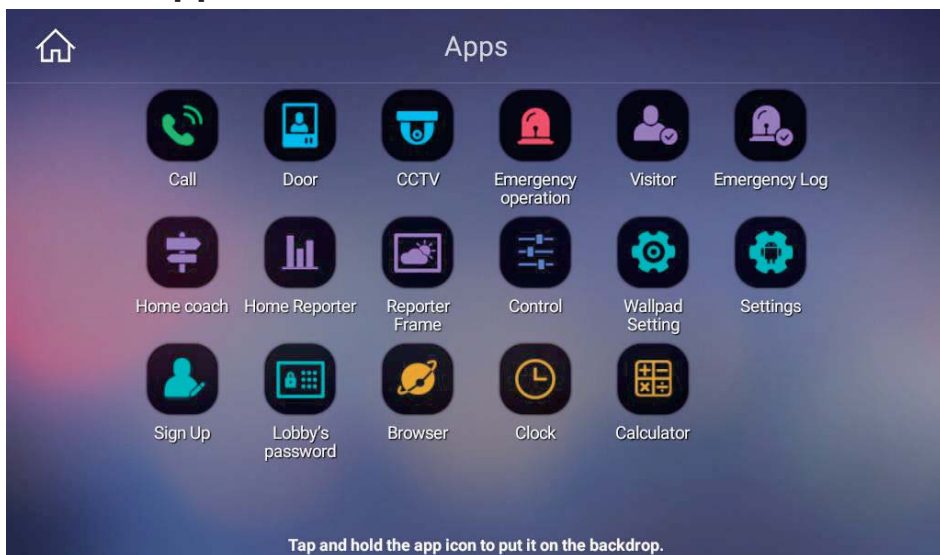

[Display for emergency log]

Delete the emergency log

- 1) With " " icon, you can delete the date of emergency log.

5.6. Etc App



 Calculator	Calculator	Calculation
 Clock	Clock	Set the alarm and time
 Sign Up	Sign up	Sign up / Edit / Initialization
 Wallpad Setting	Wallpad setting	Setting for wallpad
 OS setting	OS setting	Android setting
 Browser	Brower	Internet brower

5.6.1. Calculator



You can use it for calculation.

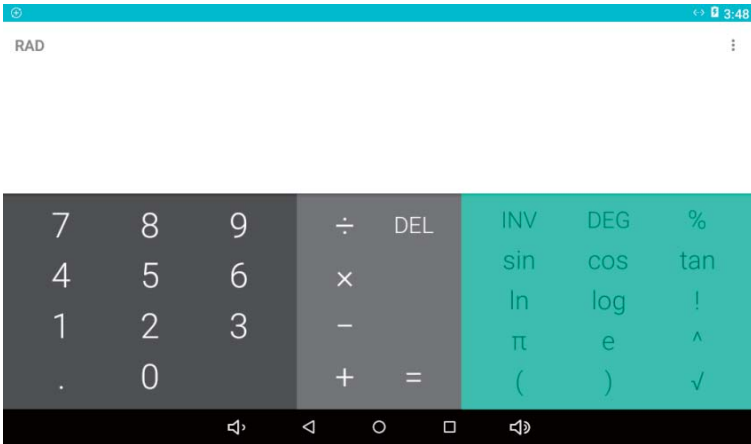

[Display for calculation]

5.6.2. Brower

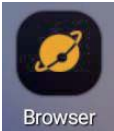

This is the web browser for internet.

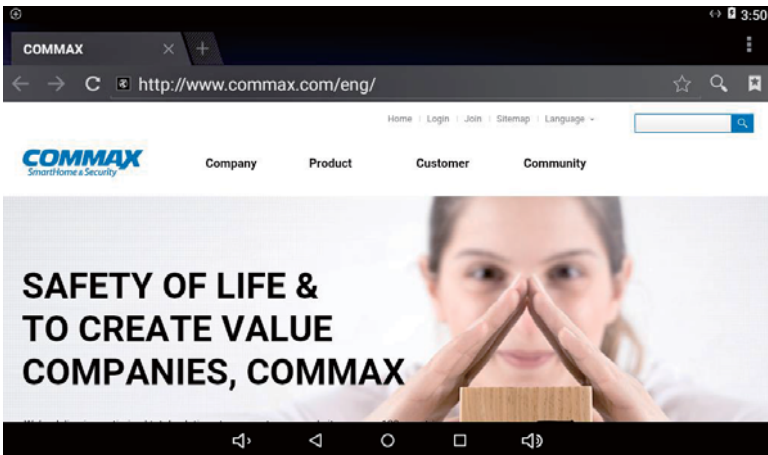

5.6.3. Sign up



Sign up / Edit / Initialization

- 1) Enter 'ID' and click 'Duplication check'.
- 2) Select the living country.
- 3) Enter 'Password', 'Retype Password' and click 'Registration'.

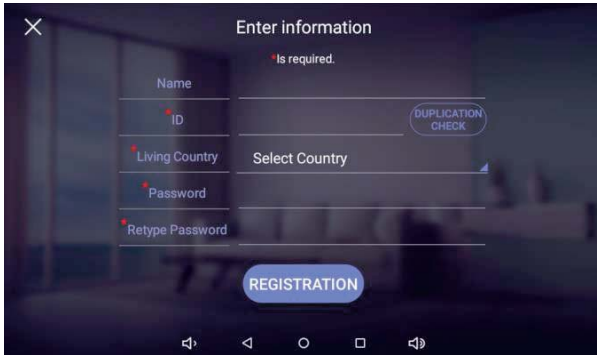

[Display for Sign-up]

Edit & Initialization

- 1) If you have already signed up, you can see the current ID on the display. You can change the password to click 'P/W change' button..
- 2) When you click 'Initialization', all your signed up information will be deleted

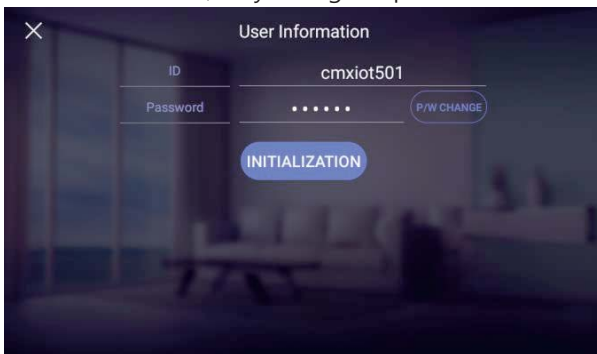

5.7. Wallpad setting

You can set the user information, wallpad, controlling devices, Door camera and other devices.

- 1) Click "Wallpad setting" icon, you can see the display.



[Display for Wallpad setting]

5.7.1. Wallpad setting

You can set the SIP server, call number of guard station and passwords for wallpad.

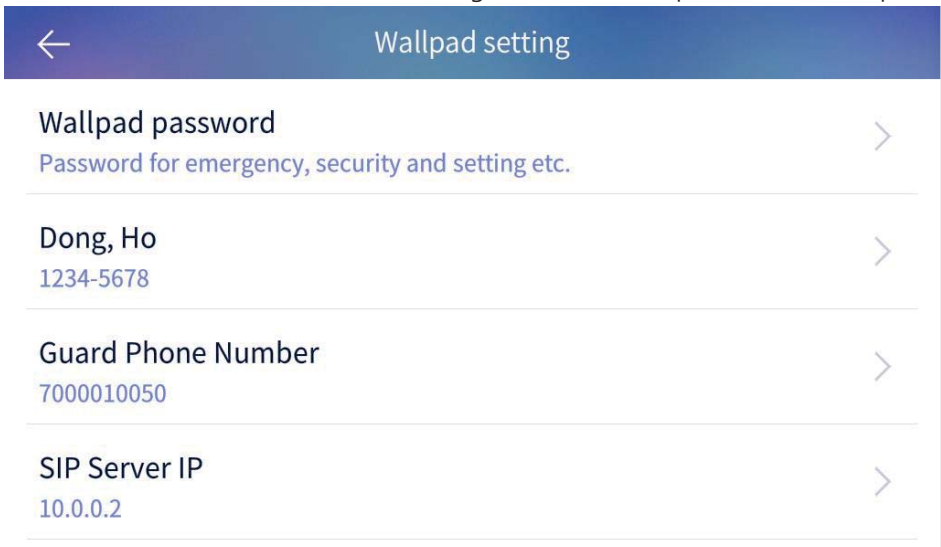

* Wallpad type setting

- You can set wallpad using Master or Slave

- If wallpad sets Slave, input IP of Master wallpad and select Slave number (501 ~ 510)

※ If you are a member of COMMAX, you need to initialize the member information before setting it as Slave.

※ After the setting of the wall pad type is completed, it is automatically rebooted.

Note) a. When operating master and slave in the cab, make sure all the IP of the wall pad is set to fixed IP

(When set to DHCP, synchronization between master and slave may not be possible.)

B. When the slave malfunctions or power is off, communication delay between master and slave occurs and all devices may slow down

There is.

C. If the IP address of the slave is changed, be sure to reboot the master wall pad to synchronize the master / slave.

D. If changing the slave wall pad to Master, be sure to reboot the existing Master Wall Pad to synchronize Master / Slave

It will be canceled.

✕ Wallpad type

Master Slave

Master wallpad IP
localhost(Master)

Extension number
100(Master)

- 1) You can change the password for disarming emergency and Away mode.
 - Enter the new password.
 - Re-enter the same password.
 - If passwords are same, it has been changed.
 - ※ Initial password is 1234.
- 2) You can change the building & household number.
 - ※ If you change those number, you need to reboot the wallpad.
- 3) You can change the number for guard station.
- 4) You can change the SIP server IP.
 - ※ If you change the IP, you need to reboot the wallpad.
- 5) You can change the update server IP for wallpad.
- 6) You can re-execute the installation wizard.

5.7.2. Initialization for connecting control devices

You can initialize the control devices for connecting wallpad or mobile app.

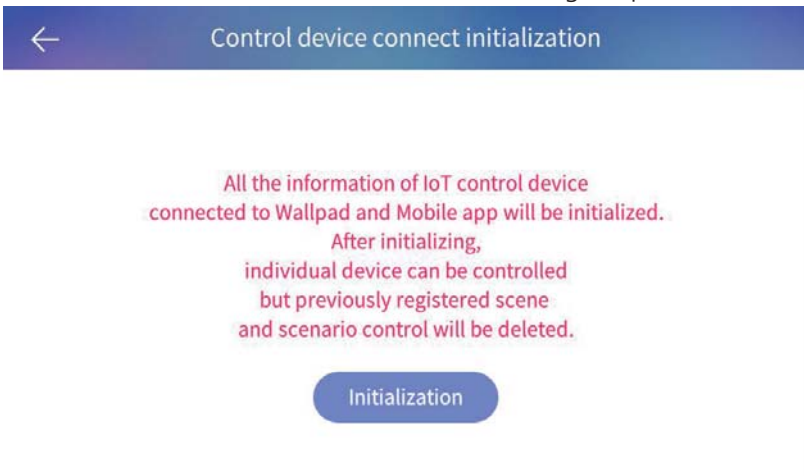

When you click the "Initialization" button, all the connecting IoT devices will be initialized. After initialization, individual devices can be controlled but all the scenario or scenes will be deleted.

5.7.3. Data initialization

You can initialize all the data from wallpad.

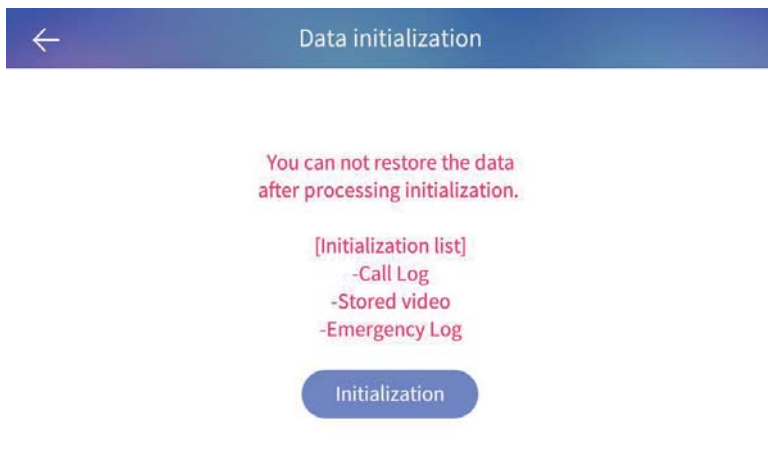

After initialization, you can not restore the data.

[List for initialization]

- Call log
- Saved image
- Saved movie clip
- Emergency log

5.7.4. Door camera setting

You can register IP door camera.

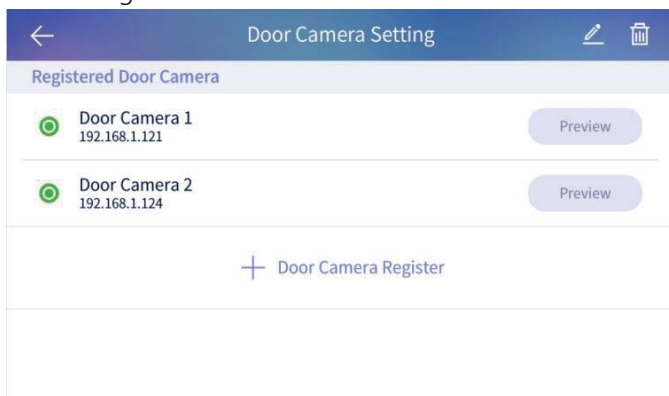

- 1) Click "Door Camera Setting", push the button of door camera for 5 seconds, the camera image will be displayed automatically.

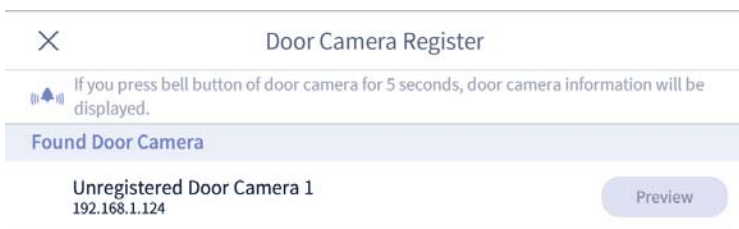

- 2) Click "Camera Preview", you can check the image of door camera.

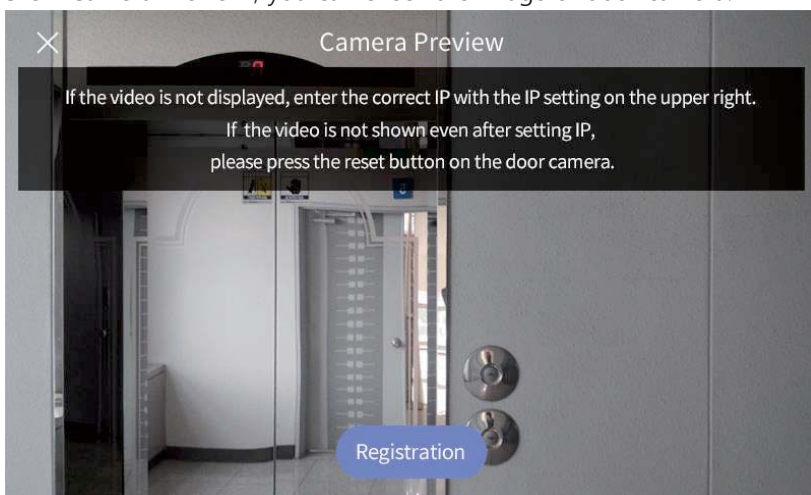

- 3) Click 'Registration' button, the door camera will be registered to wallpad automatically.
- 4) You can change the name of door camera to click "Edit" button.

5.7.5. CCTV Registration

You can register IP type CCTV camera.

- 1) Click "CCTV camera register" button, you can see the list of CCTV camera on the display..



- 2) Click "Preview" button and enter the ID & Password, you can check the image of CCTV camera.

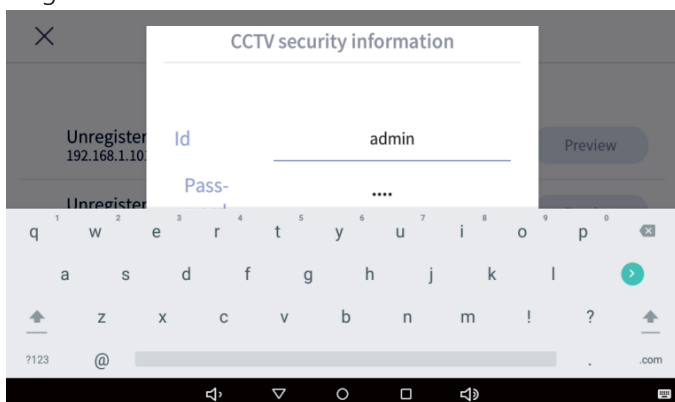



3) Click "Register" button, that CCTV camera will be registered.

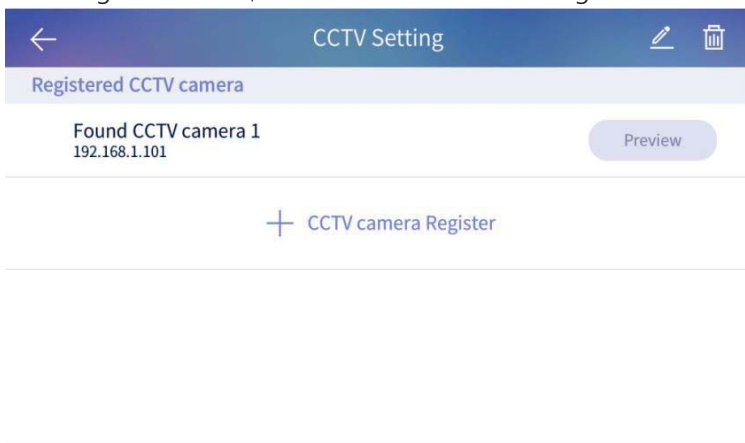

4) Click "Edit" button, you can change the name of CCTV camera.

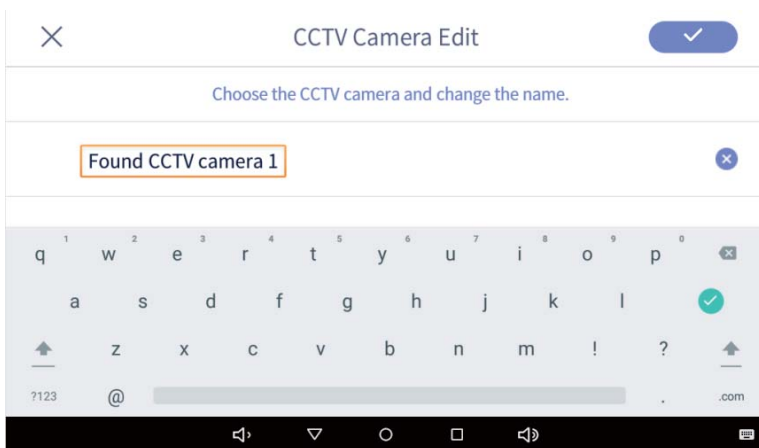

5.7.6. Call setting

You can adjust the calling functions.

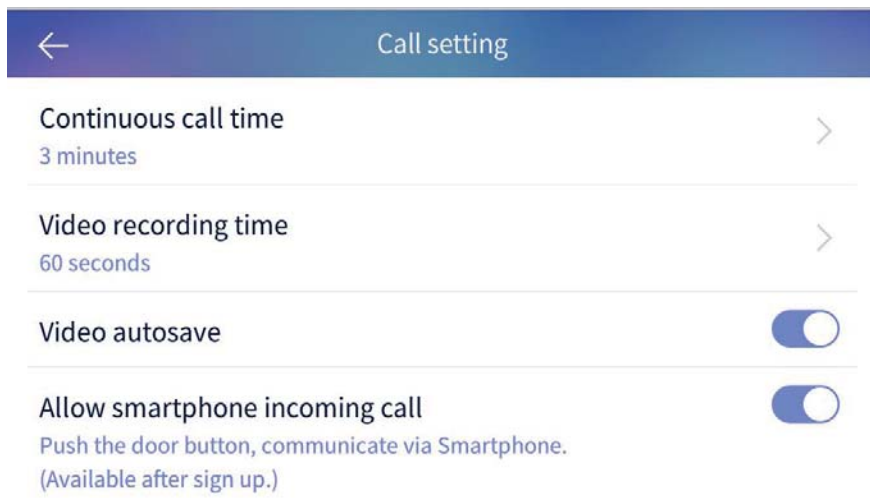

The menu is as below.

- 1) Continuous call time : You can select the call time between 30 sec ~ 3 min.
- 2) Video recording time : You can select the recording time between 10 sec ~ 60 sec.

- 3) Video auto save: When you select it, video clip will be saved automatically
Video clip will be saved on your app.
- 4) Allow smartphone incoming call : When you select it, you can receive the call from the visitors to your smart phone.

5.7.7. Setting for Home Theme

You can set the home theme.

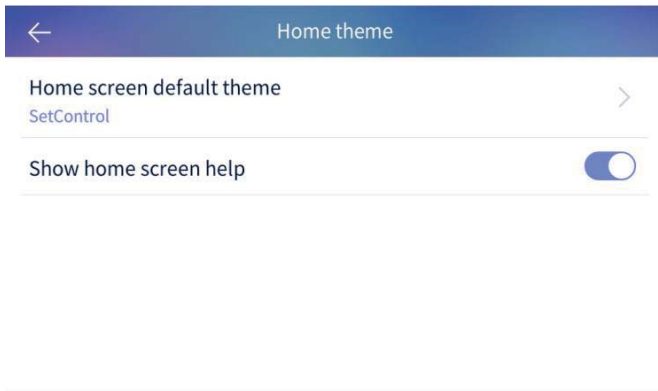

5.7.8. Ringtone

You can select the ringtone from connected devices.

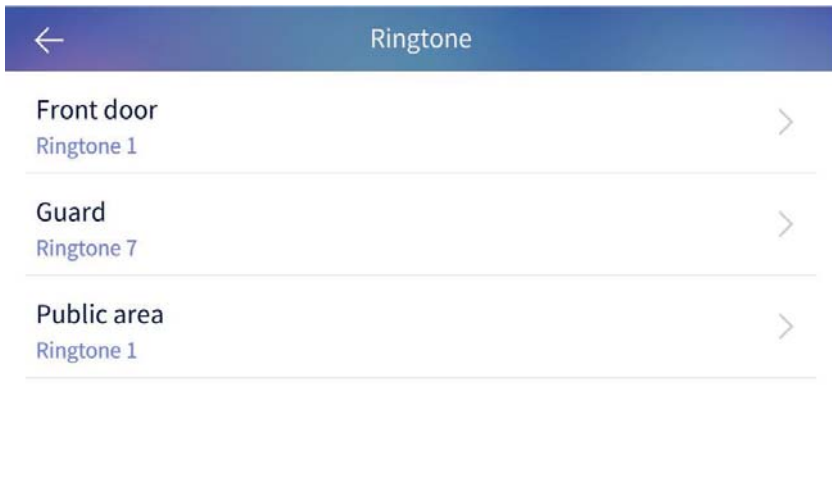

- 1) Select the place and select the ringtone. (Preview for ringtone)
- 2) Click the 'Confirm' button, the ringtone has been selected.

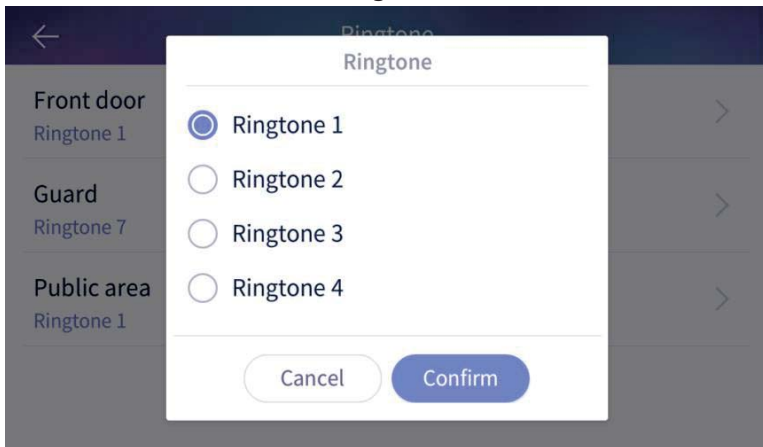

5.7.9. Wallpad information

You can check the information of systems such as versions of S/W.

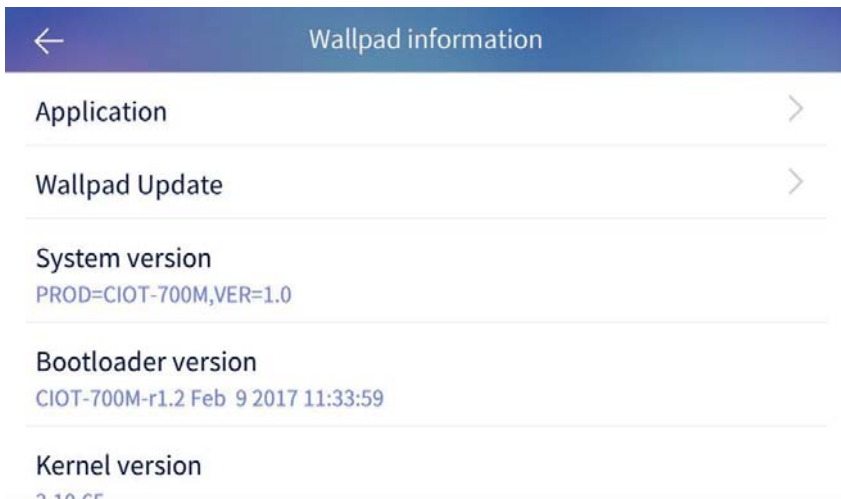

5.7.10. Check the version of application

- 1) Click "Application" button.
- 2) The version of app will be displayed.

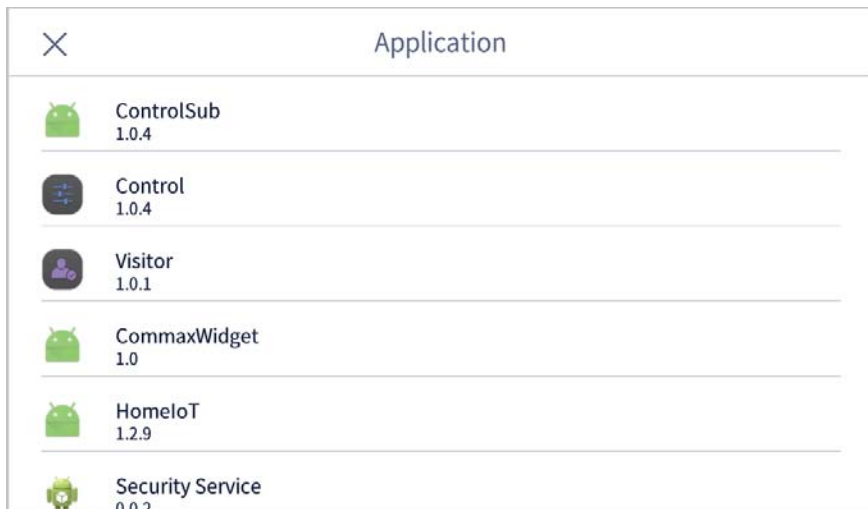

5.7.11. Touch keypad sensitivity

You can control sensitivity of keypad, if product has touch keypad.

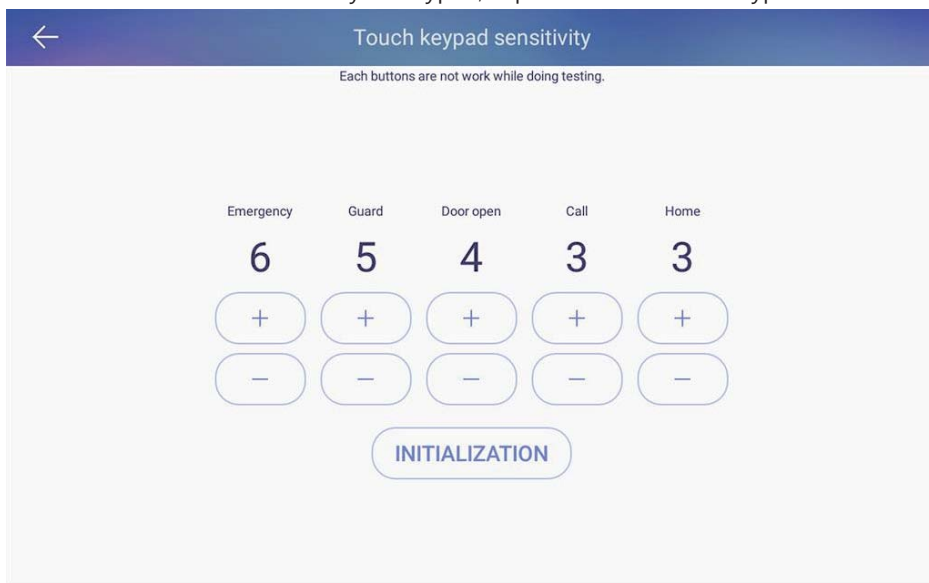

6 Scene / Booking control

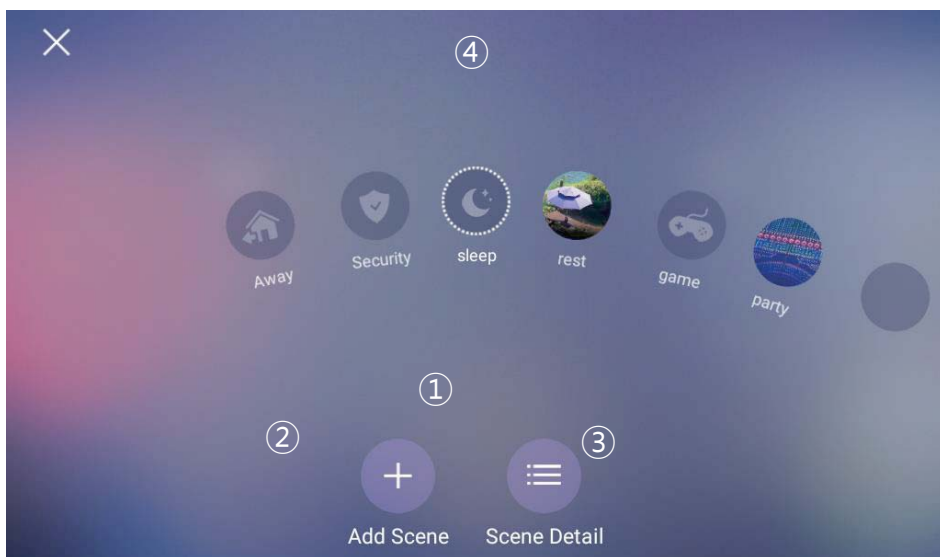

[Main display of Scene / Scenario menu]

① Move to Home display	③ Detail of Scene
② Add Scene	④ Quick move to scenario control

6.1.1. Add Scene

- 1) In the menu, click the 'Add scene' button.
- 2) Click 'Create the scene with selected device' button, you can see the selection of device window.
- 3) Selected device and click 'Confirm' button.
- 4) Select the details for devices.
- 5) Click '+' button for entering name & icon.

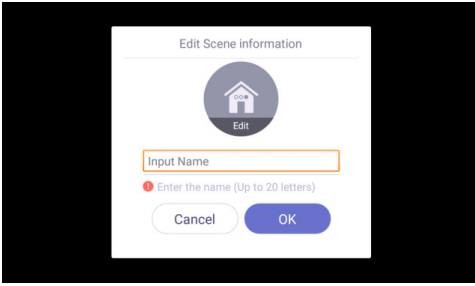

[Display for device setting]

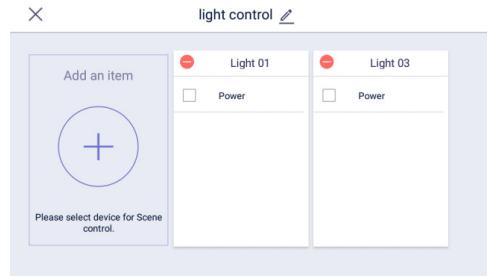

[Display for name & icon]

6.1.2. Away mode



Activate & Deactivate the away mode

Display for away mode status

You can set the sensors, saving visitor image, turn-off the light or bypass the call in the away mode..

Activate the away mode

- 1) Click the away mode icon.
- 2) After the curtain time, the away mode will be activated.
- 3) If you cancel the away mode, click "Close" button.

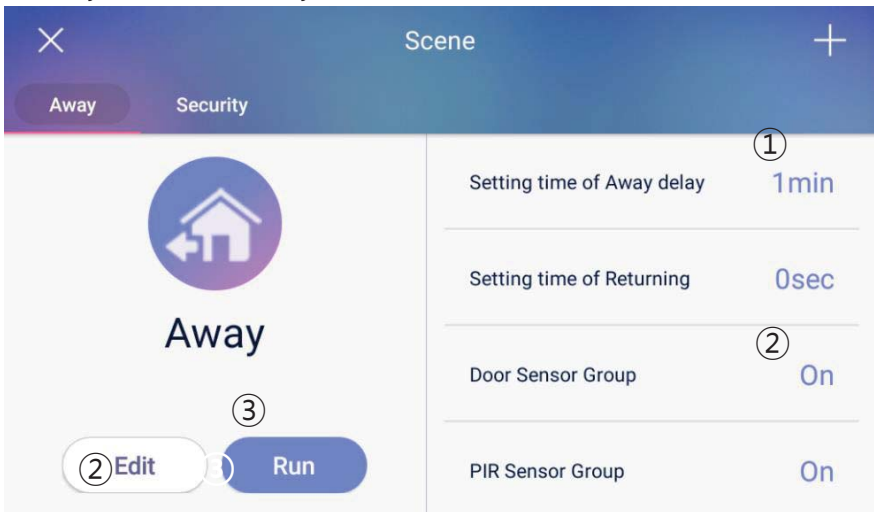

[Display for away mode]

① Lead time for Away mode	② Start the away mode
③ List for activation with away mode	

※ Away mode will not be activated during the setting of security.

※ Lead time for away mode can be set in the menu of 'Away mode setting → Option → Lead time for Away mode'.

Setting for Away mode

- 1) Setting the activating functions in away mode.
- 2) Click "Option" button, the setting menu will be displayed.
- 3) Check for using sensors or other functions.
- 4) Click 'Confirm' button for saving.

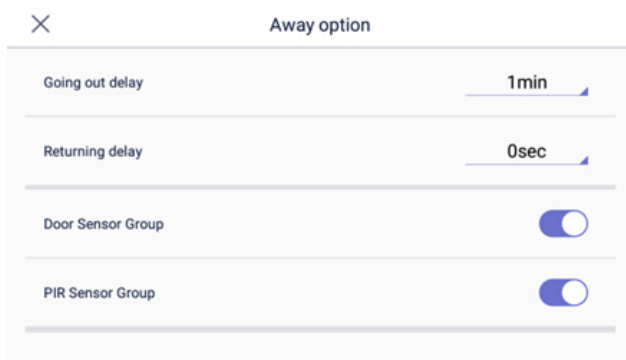

[Setting display for away mode]

Disarm for away mode

- 1) Click away mode icon in home display.
- 2) Enter the password and click 'Confirm' button.
- 3) If the password is correct, the away mode will be disarmed.

6.1.3. Security



Arm / Disarm the security

Display the status of security sensor

- ※ This function will be activated when the sensors are installed in the house.
- ※ You can choose the usage of sensors in the menu of [Setting → Signal → Usage of sensor].

Set the security

- 1) Check the security sensor in 'Security area (②)' button.
- 2) Activate the selected area to click 'Confirm(①)' button.

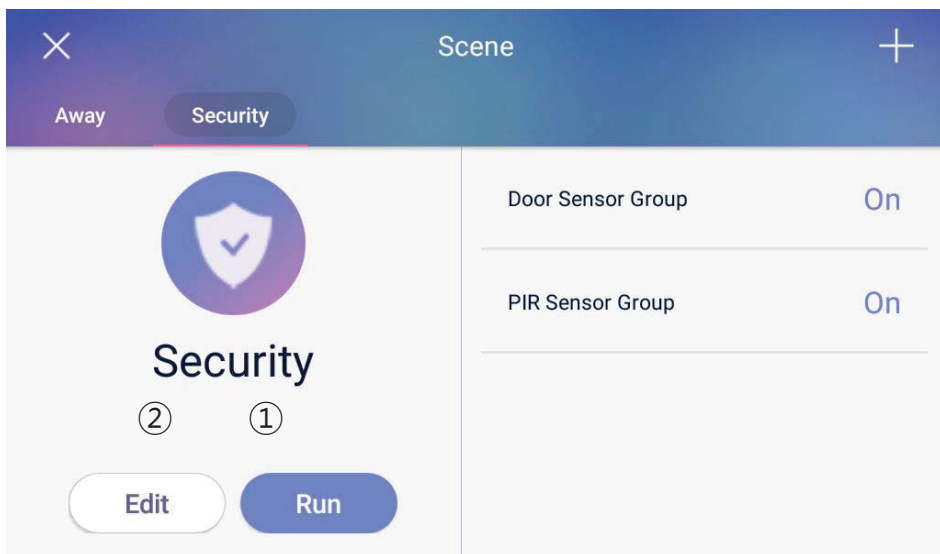

[Display for security setting]

- ※ The list of sensor will be displayed which has connected with wallpad.

Disarm the security

- 1) Click 'Security setting' button.
- 2) Enter the password and click "Confirm".
- 3) If the password is correct, the selected sensors will be disarmed.

6.1.4. Scene control

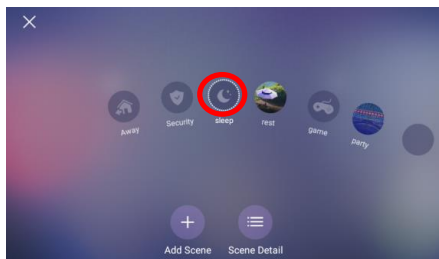

- 1) Click the scene among the list.
- 2) All the devices will be operated belongs to its scene.

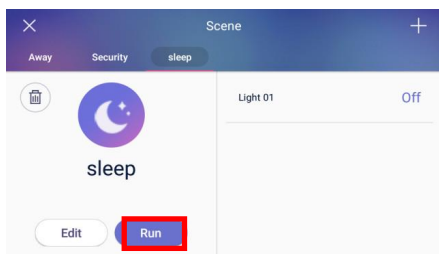

- 3) Click 'Details' in the main menu.
- 4) All the devices will be operated to click 'Apply' button.

6.1.5. Edit Scene

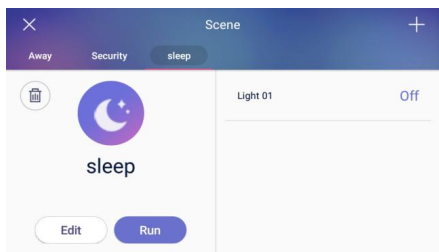

- 1) Click 'Security: Applying>' button, you can arm / disarm the security while you activate the curtain scene.
- 2) Click 'Edit' button, you can edit the scene.
- 3) In the editing display, you can edit the kinds of device, name of scene or icon.

6.1.6. Setting the scenario(Mode)

You can control the devices under the setting of scenario..

Ex.) Turn-on the Lighging when disarming the away mode

※ It may take 1 to 5 min due to server condition.

6.1.7. Adding scenario control

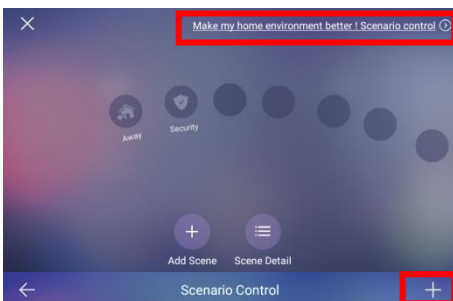

1) Click "Control the scenario" button at the right-top of display.

2) Click '+' or 'Create new scenario' button.

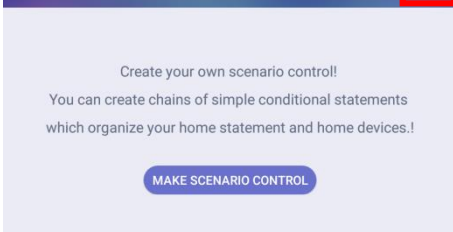

3) Click '+' button at the Condition window.

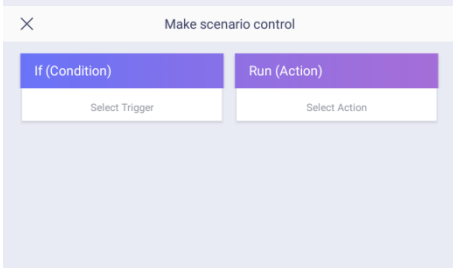

4) Select the devices.

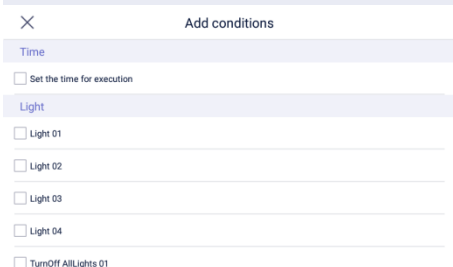

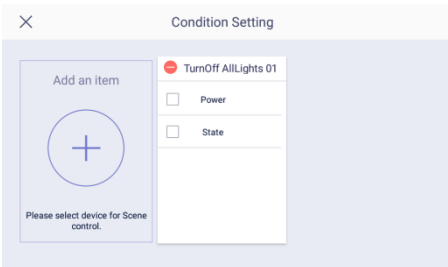

- 5) Select the options of device.
- 6) Click '✓' button for the saving.
- 7) 'Activation' will be set as same as 'Condition'.

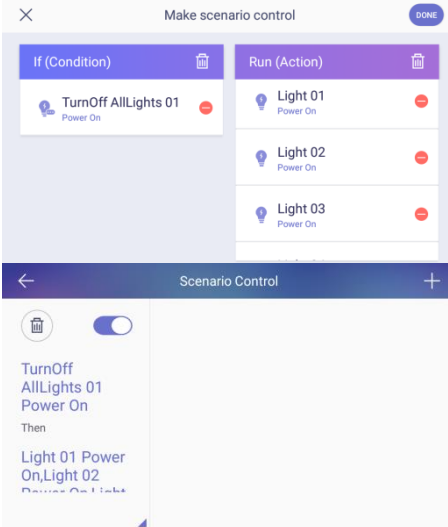

- 8) When the setting of "Condition" and "Activation" is completed, click the '✓' button for saving.

- 9) You can see the created scenario.

7.2.1. Setting for the booking

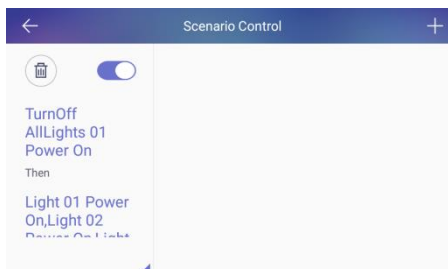

- 1) Move to Booking window.
- 2) On the list, you can activate the options using toggle buttons ('

56

PRODUCT

SPEC / MODLE	CIOT-700M
LINE	UTP (CAT.5e)
VOLTAGE	INPUT : PoE DC 36V ~ 54V / DC5V
POWER	STANDBY :3W , MAX :5W
TELECOMUNNICATION	AUDIO : VoIP, VIDEO : H.264, H.265
LINE & DISTANCE	STANDARD UTP (CAT.5e) 70m (FROM THE PSE)
TEMPERATURE	0°C ~ +40°C

SPECIFICATION

CPU	Quad-Core ARM Cortex-A53
MEMORY	1G DDR3 RAM (512M *2)
FLASH	8G eMMC Flash
LCD	7" TFT LCD, 1024 x 600
POWER	PoE

INSTALLATION

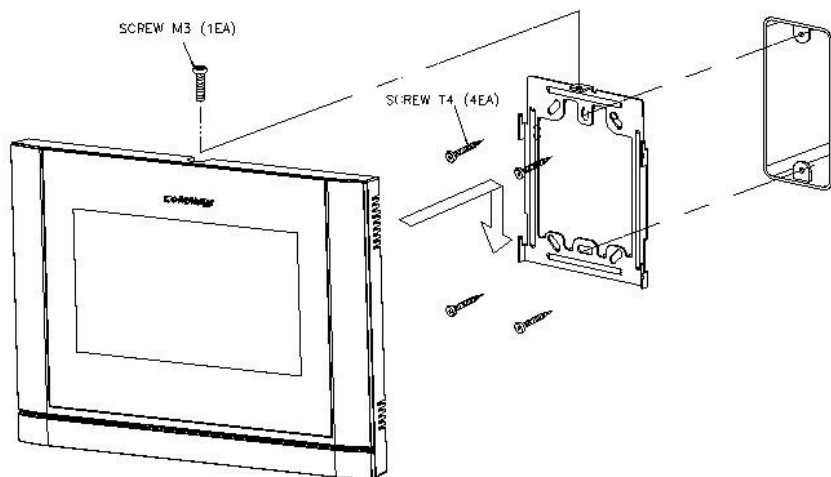

PACKAGE CONTENTS.

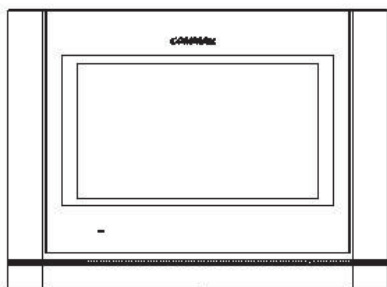

MONITOR

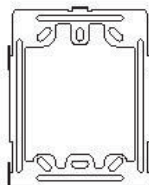

WALL BRACKET



MANUAL

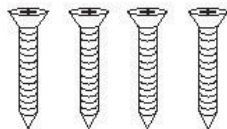

(T)4 x 18mm WALL BRACKET SCREW



(M)3 x 6mm MONITOR SCREW

COMMAX

COMMAX Co.,Ltd.

513-11, Sangdaewon-dong, Jungwon-gu, Seongnam-si, Gyeonggi-do, Korea
Int'l Business Dept. Tel. : +82-31-7393-540~550 Fax. : +82-31-745-2133
Web site : www.commax.com

PM49700M0010

Printed In Korea / 2016.03.104