

## GV-TVD8810 AI 8MP H.265 4.3x Zoom Super Low Lux WDR Pro IR Vandal Proof IP Dome



- AI Deep learning: AI Perimeter Protection & Classification (Human, Vehicle)
- 1/2.8" progressive scan low lux CMOS sensor
- Triple streams from H.265, H.264 or MJPEG
- Wide Dynamic Range Pro (WDR Pro)
- Min. illumination at 0.003 lux
- Up to 20 fps at 3840 x 2160
- Intelligent IR
- Day and night function (with removable IR-cut filter)
- Motorized varifocal lens for remote focus / zoom adjustment
- IR distance up to 40 m (130 ft)
- Vandal Resistance (IK10 for metal casing)
- Ingress protection (IP67)
- Built-in micro SD card slot (SD / SDHC / SDXC / UHS-I, Class 10) for local storage
- Two-way audio
- DC 12V / PoE (IEEE 802.3af)
- ONVIF (Profile G, S, T) conformant

### Introduction

The Dome IP Camera is an outdoor, network camera equipped with an automatic IR-cut filter and IR LEDs for day and night surveillance. The camera supports H.265 video codec to achieve better compression ratio while maintaining high quality pictures at reduced network bandwidths. GV-TVD8810 adheres to IK10 and IP67 standards, and can be powered through PoE.

Empowered by deep learning algorithms, AI technology distinguishes human and vehicles from other moving objects. Integrated with GeoVision Video Management Software (VMS), it supports AI perimeter protection, real time alert, events playback and more.

### Deep Learning Function

#### Face Detection

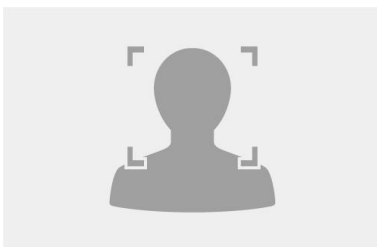

#### AI Perimeter Protection

(Intrusion, Crossing Line  
Entering Area, Leaving Area)

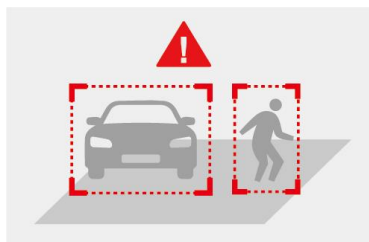

#### People Flow Counting

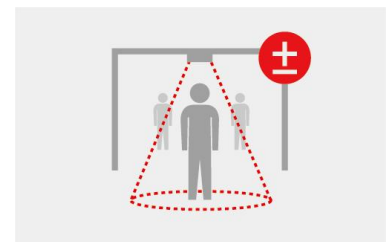

**Note:** People Flow Counting and Crowd Density Monitoring integration of the camera to GV-VMS is coming soon.

## Dimensions

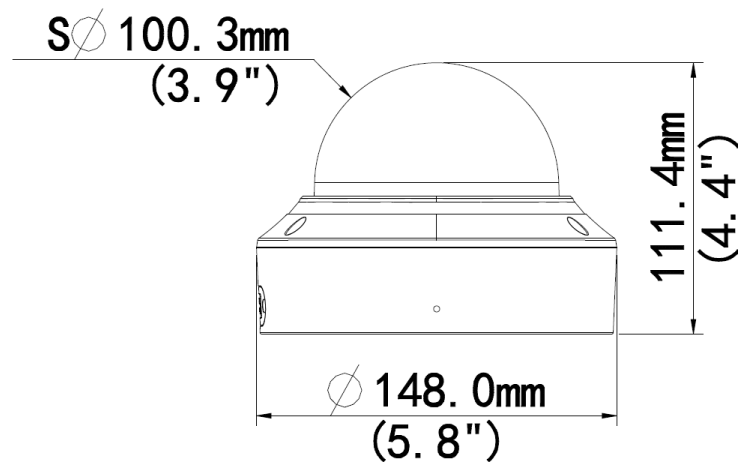

## Specifications

Camera		
Image Sensor		1/2.8" progressive scan low lux CMOS
Picture Elements		3840 (H) x 2160 (V)
Minimum Illumination	Color	0.003 Lux (F1.6, AGC ON)
	IR On	0 Lux
Shutter Speed		Auto / Manual (1 ~ 1/100000 sec)
White Balance		Auto / Manual
Gain Control		Auto / Manual
S/N Ratio		56 dB
WDR Pro		Yes
Dynamic Range		Up to 120 dB
Lens		
Megapixel		8 MP
Day / Night		Yes (with removable IR-cut filter)
Lens Type		Motorized varifocal lens
Focal Length		2.8 ~ 12 mm
Maximum Aperture		F/1.6
Mount		$\varnothing 14$ mm
Horizontal FOV		29.2° ~ 107.4°
Operation	Focus	Auto / Manual
	Zoom	4.3x Optical Zoom
	Iris	Fixed
IR LED Quantity		2 IR LEDs
Max. IR Distance		40 m (130 ft)
Operation		
Video Compression		H.265, H.264, MJPEG
Video Streaming		Triple streams
Video Resolution	Main Stream	3840 x 2160 (Default), 3072 x 1728, 2560 x 1440, 1920 x 1080
	Sub Stream	1920 x 1080, 1280 x 720, 720 x 576, 704 x 288, 640 x 360 (Default), 352 x 288
	Third Stream (Closed by Default)	720 x 576, 704 x 288, 640 x 360, 352 x 288
Frame Rate		20 fps at 3840 x 2160, 25 fps at 3072 x 1728 / 2560 x 1440, 30 fps at 1920 x 1080 (60 / 50 Hz) *The frame rate and performance may vary depending on the number of connections and data bitrates (different scenes).
Video Analytics		Motion Detection, Tampering Alarm, Audio Detection *Tampering alarm and Audio detection are only accessible through the camera's Web interface, which can be used to trigger alerts such as e-mail and FTP
Image Setting		Brightness, Contrast, Saturation, Sharpness, Flicker-less, Image Orientation (Flip, Mirror, 0°, 90°, 180°, 270°-including Corridor format)

Audio Compression	G.711	
Audio Support	Two-way Audio (external speaker required)	
Digital I/O	Input	1 Input, dry contact, NO / NC
	Output	1 Relay Output (1A 30V DC / 0.3A 125V AC)
<b>Deep Learning Function</b>		
AI Analytics	Intrusion, Crossing Line, Entering Area, Leaving Area (Human & Vehicle classification), Face Detection, People Flow Counting, Crowd Density Monitoring	
<b>Network</b>		
Interface	10/100 Ethernet	
Protocol	802.1x, ARP, DHCP, DDNS, DNS, DynDNS, FTP, HTTP, HTTPS, ICMP, IGMP, IPv4, NTP, PPPoE, RTCP, RTP, RTSP, SMTP, SNMP, TCP, UDP, UPnP, ONVIF (Profile G, S, T)	
<b>Mechanical</b>		
Camera Angle Adjustment	Pan	0 ~ 360°
	Tilt	0 ~ 68°
	Rotate	0 ~ 360°
Connectors	Power	DC Jack, PoE
	Ethernet	RJ-45
	Audio	1 In (built-in or external microphone with power supply) 1 Out (Audio Out Wire)
	Digital I/O	4-pin terminal block pitch 3.5 mm (0.14")
	Local Storage	Micro SD card slot (SD / SDHC / SDXC / UHS-I, Class 10) * UHS-II card type is not supported.
<b>General</b>		
Operating Temperature	-30 ~ 60°C (-22 ~ 140°F)	
Humidity	0 ~ 95% (no condensation)	
Power Source	12 V DC / PoE (IEEE802.3af)	
Max. Power Consumption	5.5 W	
Dimensions	Ø148 x 111 mm (Ø5.8 x 4.4")	
Weight	0.45 kg (0.99 lb)	
Ingress Protection	IP67	
Vandal Resistance	IK10 for metal casing	
Regulatory	FCC, CE, RoHS compliant	
<b>Web Interface</b>		
Installation Management	Web-based configuration	
Maintenance	Firmware upgrade through Web Browser or GV-IP Device Utility	
Access from Web Browser	Live View, Video Recording, Change Video Quality, Bandwidth Control, Image Snapshot, Text Overlay, Image Masking	
Language	Czech, English, French, German, Hungarian, Italian, Japanese, Polish, Portuguese, Russian, Spanish, Traditional Chinese	
<b>Software Application</b>		
Software Supported	GV-VMS (V17.4.1 / V18.2.1), GV-DVR / NVR (V8.9.1), GV-Control Center (V3.8.0), GV-Recording Server / Video Gateway (V2.0.0), GV-Edge Recording Manager Win version (V2.0.0), GV-Redundant / Failover Server (V1.2.0)	
Smart Device Access	GV-Eye for iOS and Android	
Live Viewing	Browser (IE, Edge, Chrome), Mobile App	











**Note:**

1. It is required to apply patch files to all or some of the supported software.
2. Do not use clothes or any ordinary material to clean the camera cover since they may result in scratches.
3. Specifications are subject to change without notice.

**Packing List**

- |                                    |                          |
|------------------------------------|--------------------------|
| 1. GV-TVD8810 IR Vandal Proof Dome | 4. Drill Template Paster |
| 2. Waterproof Rubber Set           | 5. Torx Wrench           |
| 3. Screw Kit                       | 6. Download Guide        |

## Accessories

Model No.	Name		Details
GV-Mount107 (must be used with GV-Mount212-2)	Pendant Bracket		Dimensions: $\varnothing$ 120 x 334 mm ( $\varnothing$ 4.72" x 13.15") Weight: 0.74 kg (1.63 lb)
GV-Mount211-2	Wall Mount and Junction Box		Dimensions: $\varnothing$ 253 x 125 x 125 mm ( $\varnothing$ 10 x 4.9 x 4.9") Weight: 0.92 kg (2.02 lb)
GV-Mount212-2	Wall Box Mount		Dimensions: $\varnothing$ 145 x 40 mm ( $\varnothing$ 5.7 x 1.6") Weight: 0.24 kg (0.5lb)
GV-Mount300-2	Convex Corner Mount		Dimensions: 137 x 233 x 160 mm (5.4" x 9.17" x 6.3") Weight: 1.65 kg (3.64 lb)
GV-Mount310-2	Concave Corner Mount		Dimensions: 111.2 x 369.9 x 210 mm (2.6" x 11.4" x 6.6") Weight: 1.65 kg (3.64 lb)
GV-Mount420 (must be used with GV-Mount211-2)	Pole Mount Bracket		Dimensions: $\varnothing$ 20 x 120 x 53.4 mm ( $\varnothing$ 4.7 x 4.7 x 2.1") Steel Strap Diameter: $\varnothing$ 67 ~ 127 mm ( $\varnothing$ 2.6" ~ 5") Weight: 0.45 kg (0.99 lb)
GV-Mount606	In-Ceiling Mount		Dimensions: $\varnothing$ 235 x 63 mm ( $\varnothing$ 9.3" x 2.5") In-ceiling hole: $\varnothing$ 195 mm ( $\varnothing$ 7.67") Weight: 0.49 kg (1.1 lb)
GV-Mount704 (must be used with GV-Mount107)	Extension Tube		Dimensions: $\varnothing$ 3.5 x 10 or 20 or 30 or 50 cm ( $\varnothing$ 1.38 x 3.9 or 7.9 or 11.8 or 19.7") Weight: 225g or 360g or 500g or 780g (0.5 lb or 0.79 lb or 1.1 lb or 1.72 lb)
GV-Mount921 (for standard US single and double gang boxes only)	Power Box Mount Bracket		Dimensions: $\varnothing$ 145 x 13 mm ( $\varnothing$ 5.7" x 0.5") Weight: 0.13 kg (0.29 lb)
GV-PA191	Power over Ethernet (PoE) Adapter		GV-PA191 is a Power over Ethernet (PoE) adapter designed to provide power to the IP device through a single Ethernet cable.

GV-POE Switch	GV-POE Switch is designed to provide power along with network connection for IP devices. The GV-POE Switch is available in various models with different numbers and types of ports.
Power Adapter	Contact our sales representatives for the countries and areas supported.