

GV-VD2712 Starlight 2MP H.265 4.3x Zoom Super Low Lux WDR Pro IR Vandal Proof IP Dome



- 1/2.8" progressive scan super low lux CMOS
- Min. illumination at 0.004 lux
- Triple streams from H.265, H.264 and MJPEG
- Up to 30 fps at 1920 x 1080
- Vandal resistance (IK10 for metal casing)
- Ingress protection (IP67)
- Motorized varifocal lens for remote focus/zoom adjustment
- P-iris lens for auto iris control
- Intelligent IR
- IR distance up to 30 m (100 ft)
- Day and Night function (with removable IR-cut filter)
- 3-axis mechanism (pan / tilt / rotate)
- DC 12V / PoE (IEEE 802.3af)
- Two-way audio
- Wide Dynamic Range Pro (WDR Pro)
- 3D noise reduction
- Smart streaming
- Defog
- Motion detection
- Tampering alarm
- Text overlay
- Privacy mask
- IP address filtering
- Recording assigned by GV-Edge Recording Manager ([Windows & Mac](#))
- Supports iPhone, iPad, Android & 3GPP
- 31 languages on Web interface
- ONVIF (Profile S, T) conformant

* Smart streaming requires GV-DVR / NVR V8.7.0.0, GV-VMS V16.10.3 or later software versions.

Introduction

The Vandal Proof IP Dome is an outdoor camera designed with IK10 vandal resistance and IP67 ingress protection. With its motorized varifocal lens, the user can zoom and focus the camera from the Web interface. The camera can support H.265 video codec to achieve better compression ratio while maintaining high quality pictures at reduced network bandwidths. For night operations, the camera allows up to 30 m (100 ft) IR effective distance. GV-VD2712 is capable of not only providing a color live view in near darkness but also under contrasting light intensities with its super low lux CMOS image sensor and WDR Pro.

Active Tampering Alarm

Tampered



Focus Change



Camera Shift

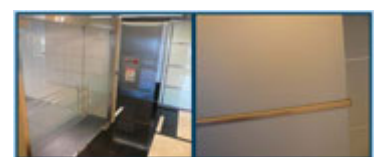

Dimensions

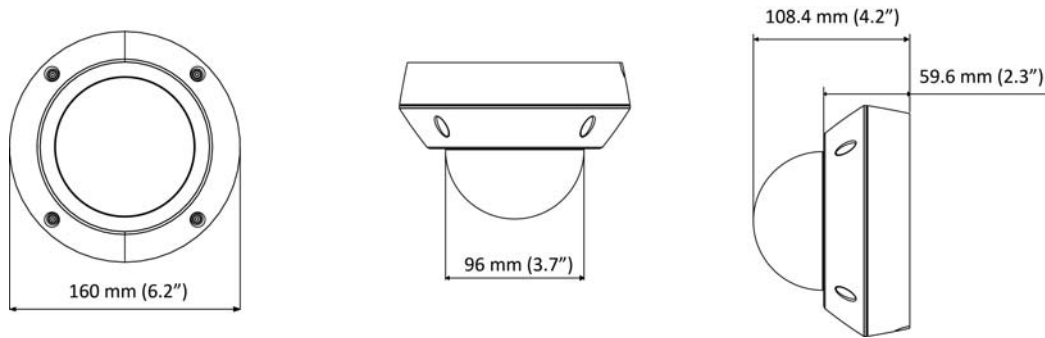

Specifications

Camera		
Image Sensor	1/2.8" progressive scan super low lux CMOS	
Picture Elements	1920 (H) x 1080 (V)	
Minimum Illumination	Color	0.005 Lux
	B/W	0.004 Lux
	IR ON	0 Lux
Shutter Speed	Automatic, Manual (1/5 ~ 1/16000 sec.)	
White Balance	Automatic, Manual (2800K ~ 8500K)	
Gain Control	Automatic	
S/N Ratio	56 dB	
WDR	WDR Pro	
Dynamic Range	Up to 130 dB	
Lens		
Megapixel	Yes	
Day/Night	Yes (with removable IR-cut filter)	
Focal Length	2.8 ~ 12 mm	
Lens Type	Motorized varifocal lens	
Maximum Aperture	F/1.7	
Mount	Ø14 mm	
Horizontal FOV	110° ~ 38°	
Image Format	1/2.7"	
Operation	Focus	Auto focus
	Zoom	4.3x optical zoom
	Iris	P-iris
IR LED Quantity	4 IR LEDs	
Max. IR Distance	30 m (100 ft)	
Operation		
Video Compression	H.265, H.264, MJPEG	
Video Streaming	Stream 1 from H.265 or H.264 Stream 2 from H.265, H.264 or MJPEG Stream 3 from H.265, H.264 or MJPEG	
Frame Rate	50 Hz: 25 fps at 1920 x 1080 60 Hz: 30 fps at 1920 x 1080 * The frame rate and the performance may vary depending on the number of connections and data bitrates (different scenes).	
Image Setting	Brightness, Contrast, Saturation, Sharpness, Gamma, White Balance, Flicker-less, Image Orientation (Flip, Mirror, 0°, 90°, 180°, 270°-including Corridor format), Shutter Speed, D/N Sensitivity, Backlight Compensation, WDR, Defog, Low Lux Enhancement, Denoise, Metering	
Audio Compression	G.711	
Audio Support	Two-way Audio (external microphone and speaker required)	
Sensor Input	1 input (dry contact)	
Alarm Output	1 digital output (200 mA 5V DC)	

Video Resolution		
Main Stream	4:3	1280 x 960, 640 x 480
	16:9	1920 x 1080 (Default), 1280 x 720, 640 x 360
	5:4	1280 x 1024, 640 x 512
Sub Stream	4:3	1024 x 768, 640 x 480, 320 x 240
	16:9	1280 x 720, 640 x 360 (Default), 448 x 256
	5:4	1280 x 1024, 640 x 512, 320 x 256
Third Stream (Closed by Default)	4:3	640 x 480, 320 x 240
	16:9	640 x 360, 448 x 256
	5:4	640 x 512, 320 x 256
Network		
Interface	10/100 Ethernet	
Protocol	DHCP, DNS, DynDNS, FTP, HTTP, HTTPS, ICMP, 3GPP/ISMA, IPv4, IPv6, Multicast, NTP, ONVIF (Profile S, T), QoS (DSCP), RTCP, RTSP, SMTP, SNMP, SSL, TCP/IP, UDP, UPnP	
Security Feature	<ul style="list-style-type: none"> - No default ID and Password - 802.1x authentication - HTTPS with a SSL certificate stored in the camera - 256-bit AES encryption (requires firmware V1.14 or later working with GV-VMS V18.1 or later) 	
Mechanical		
Temperature Detector	Yes	
Camera Angle Adjustment	Pan	0° ~ 350°
	Tilt	0° ~ 75°
	Rotate	0° ~ 340°
Connectors	Power	2-pin terminal block, PoE
	Ethernet	Ethernet (10/100 Base-T), RJ-45 cable
	Audio	1 In (microphone jack, 3.5 mm / 0.14") 1 Out (stereo phone jack, 3.5 mm / 0.14")
	Digital I/O	I/O wires
	Local Storage	Micro SD card slot (SD/SDHC/SDXC/UHS-I, Class 10) *UHS-II card type is not supported.
TV-Out	BNC connector	
LED Indicator	2 LEDs: Power, Status	
General		
Environment Temperature	Start-up	-20 °C ~ 60 °C (-4°F ~ 140°F)
	Operation	
Humidity	10% to 90% (no condensation)	
Power Source	12V DC / PoE (IEEE 802.3af)	
Max. Power Consumption	8.64 W	
Dimension	ø160 x 108.4 mm (6.2 x 4.27")	
Weight	1.15 kg (2.54 lb)	
Ingress Protection	IP67	
Vandal Resistance	IK10 for metal casing	
Regulatory	CE, FCC, RCM, LVD, RoHS compliant	
Power over Ethernet		
PoE Standard	PoE (IEEE 802.3af Power over Ethernet / PD)	
PoE Power Supply Type	End-Span and Mid-Span	
PoE Power Output	Per Port 48V DC, 350 mA. Max. 15.4 watts	
Web Interface		
Installation Management	Web-based configuration	
Maintenance	Firmware upgrade through Web Browser or Utility	
Access from Web Browser	Camera Live View, Video Recording, Change Video Quality, Bandwidth Control, Image Snapshot, Audio, Picture in Picture, Picture and Picture, Privacy Mask, Text Overlay, Digital PTZ	
Language	Arabic / Bulgarian / Czech / Danish / Dutch / English / Finnish / French / German / Greek / Hebrew / Hungarian / Indonesian / Italian / Japanese / Lithuanian / Norwegian / Persian / Polish / Portuguese / Romanian / Russian / Serbian / Simplified Chinese / Slovakian / Slovenian / Spanish / Swedish / Thai / Traditional Chinese / Turkish	

Applications

Software Supported	GV-DVR / NVR (V8.7.1.0), GV-VMS (V15.11.3.0), GV-Control Center (V3.4.0.0), GV-Edge Recording Manager (V1.2.0.0), GV-Center V2 (V15.10.0.0), GV-Recording Server / Video Gateway (V1.3.0.0), GV-Redundant / Failover Server (V1.1.0.0)
Smart Device Access	GV-Eye for iOS and Android
Live Viewing	Browser (IE, Chrome, Firefox, Safari), Mobile app
CMS Server support	GV-Control Center, GV-Center V2, GV-Vital Sign Monitor

Note:

1. It is required to apply patch files to all the supported software mentioned above.
2. The signal range and data throughput may vary depending on the network conditions and environmental factors.
3. Specifications are subject to change without prior notice.







Packing List

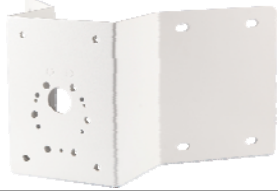

- | | |
|----------------------------|--|
| 1. H.265 Vandal Proof Dome | 11. Waterproof Rubber Sets
(for RJ-45 Cat.5 and DC 12V / for RJ-45 Cat.6) |
| 2. Screw x 4 | 12. Torx Wrench |
| 3. Screw Anchor x 4 | 13. Big Concave Hexagon Wrench |
| 4. TV-Out Wire | 14. Small Concave Hexagon Wrench |
| 5. Audio Wires x 2 | 15. Silica Gel Bag |
| 6. I/O Cable | 16. Sticker (for Silica Gel Bag) |
| 7. Installation Sticker | 17. Ruler |
| 8. Conduit Converter | 18. Download Guide |
| 9. PG21 Conduit Connector | 19. Warranty Card |
| 10. RJ-45 Connector | |

Note: Power adapters can be purchased upon request.

Accessories

Model No.	Name		Details
GV-Mount100	Straight Tube and Junction Box Kit		Dimensions: 200 x 170 x 257.5 mm (7.9 x 6.7 x 10.1") Weight: 3.17 kg (6.99 lb)
GV-Mount101	Straight Tube Kit		Dimensions: 219 x 125 x 332 mm (8.6 x 4.9 x 13.1") Weight: 1.8 kg (3.97 lb)
GV-Mount200	Wall Pendant Mount		Dimensions: 225 x 140 x 250 mm (8.9 x 5.5 x 9.8") Weight: 900 g (1.98 lb)
GV-Mount203	Wall Mount and Junction Box		Dimensions: 315 x 195.5 x 225 mm (12.4 x 7.7 x 8.9") Weight: 2.95 kg (6.5 lb)

Model No.	Name		Details
GV-Mount206	Wall Box Mount		Dimensions: 126.5 x 211.3 x 176.85 mm (5 x 8.3 x 6.96") Weight: 0.93 kg (2.06 lb)
GV-Mount300-1	Convex Corner Adapter Kit		Dimensions: 238.6 x 395.2 x 210 mm (9.4" x 15.5" x 8.2") Weight: 4.27 kg (9.41 lb)
GV-Mount310-1	Concave Corner Adapter Kit		Dimensions: 111.2 x 369.9 x 210 mm (4.37" x 14.5" x 8.2") Weight: 2.96 kg (6.53 lb)
GV-Mount400-1	Pole Mount Bracket Kit (Ø 4 ~ 6")		Bracket: 68.4 x 240 x 163 mm (2.69" x 9.44" x 6.41") Weight: 1.70 kg (3.75 lb) Steel Strap Diameter: Ø 4" ~ 6"
GV-Mount410-1	Pole Mount Bracket Kit (Ø 6 ~ 7.5")		Bracket: 68.4 x 240 x 163 mm (2.69" x 9.44" x 6.41") Weight: 1.70 kg (3.75 lb) Steel Strap Diameter: Ø 6" ~ 7.5"
GV-Mount702	Extension Tube		Four options are available. Dimensions: Ø 5.4 x 10 or 20 or 30 or 50 cm (Ø 2.1 x 3.9 or 7.9 or 11.8 or 19.7") Weight: 180 g or 390 g or 550 g or 800 g (0.4 lb or 0.86 lb or 1.21lb or 1.76 lb)
GV-Mount903-1	Dome Housing		Dimensions: Ø 185.51 x 165.35 mm (Ø 7.3" x 6.51") Weight: 900 g (1.98 lb)
GV-Mount916	In-Ceiling Mount		Dimensions: Ø 205 x 63.8 mm (Ø 8 x 2.5") Weight: 645 g

Model No.	Name	Details
GV-PA191		<p>Dimensions (H x W x D): 43 x 69 x 40 mm (1.69 x 2.72 x 1.57")</p> <p>Weight: 130 g (0.29 lb)</p>
GV-POE Switch	<p>GV-POE Switch is designed to provide power along with network connection for IP devices. The GV-POE Switch is available in various models with different numbers and types of ports.</p>	
GV-Relay V2		<p>GV-Relay V2 is designed to expand the voltage load of GV IP devices. It provides 4 relay outputs, and each can be set as normally open (NO) or normally closed (NC) independently as per your requirement.</p>
Metal PG21	Conduit Connector	
Power Adapter		<p>Contact our sales representatives for the countries and areas supported.</p>