

Installation Guide

Model Name	Model No.
Video Intercom System	VL-SV71
	VL-SV72
Main Monitor Station	VL-MV71
	VL-MV72

- This guide is for use with the above 4 models.



Door station

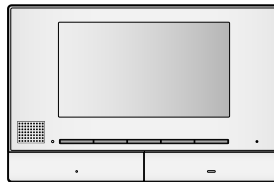

Main monitor station

- The Installation Guide in Indonesian can be accessed from the following site:
<https://panasonic.net/cns/pcc/support/intercom/sv71>
- Door station is described as "doorphone" and Main monitor station is described as "main monitor" in this guide.
- In this guide, the suffix of each model number (e.g., the "BX" in "VL-SV71BX") is omitted unless necessary.

Note to the installer

- Before attempting to connect or operate this product, please read the label on the rear of the doorphone and the main monitor/extension monitor.
- Please read this guide carefully, and install the product safely and correctly by following the instructions. Carefully read the information found in the section titled "For your safety" in particular.
- Only use attachments/accessories specified by the manufacturer.
- The installation shall be carried out in accordance with all applicable installation rules.
- To the maximum extent permitted by law, Panasonic assumes no responsibility for injuries or property damage resulting from failures arising out of improper installation or operation inconsistent with this document.
- After installation, make sure to leave this guide with the customer.

For your safety

To prevent severe injury and loss of life/property, read this section carefully before using the product to ensure proper and safe operation of your product.



Preventing fire, electric shock and short circuits

- **Leave installation work to the dealer. Installation work requires technique and experiences. Failure to observe this may cause fire, electric shock, injury, or damage to the product. Consult the dealer.**
- **Electrical connection work should be performed by certified personnel only. Certification is required for performing electrical connection work. Consult your dealer.**
- Use only the specified power supply unit and AC cable.
- Do not attempt to disassemble or modify this product. Contact an authorised service centre for repairs.
- Never install wiring during a lightning storm.
- Do not connect non-specified devices.
- Do not connect a power cable to a terminal that is not specified in this guide.
- When opening holes in walls for installation or wiring, or when securing the power cable, make sure you do not damage existing wiring and ductwork.
- Do not make any wiring connections when the power supply is turned on.

- Do not use the supplied power supply unit for outdoor installations (it is for indoor use only).
- Do not install the main monitor/extension monitor in the following places:
 - Places where the main monitor/extension monitor may be splashed with water or chemicals.
 - Places where there is a high concentration of dust, or high humidity.
- Do not perform any actions (such as fabricating, twisting, stretching, bundling, forcibly bending, damaging, altering, exposing to heat sources, or placing heavy objects on the power cable) that may damage the power cable. Using the product with a damaged power cable may cause electric shock, short circuits, or fire. Contact an authorised service centre for repairs.
- When existing chime wires are used, it is possible that they contain AC voltage. Contact an authorised service centre.



Preventing electric shock

- If the wiring is underground, do not make any connections underground.
- If the wiring is underground, use a protection tube.
- If the wiring is outdoors, use a protection tube or a surge protector.







Preventing injury

- Install the product securely adhering to the instructions in this guide to

prevent it from falling off the wall.
Avoid installing onto low-strength walls, such as gypsum board, ALC

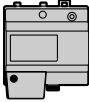
(autoclaved lightweight concrete), concrete block, or veneer (less than 18 mm thick) walls.

Supplied accessories for installation

For the doorphone^{*1}		
 Screw × 2 (3.8 mm × 20 mm)		
For the main monitor/extension monitor		
 Mounting bracket × 1	 Screw × 2 (4 mm × 16 mm)	
Power supply unit and related items^{*2}		
 Power supply unit × 1 (VL-PS241)	 AC cable × 1	 Cable binder × 1  Screw × 2 (4 mm × 40 mm)

Important:

- You will need the following additional items to install and configure the doorphone and the main monitor/extension monitor.

[Locally procured]

- Power cables (AC/DC cables)^{*2} and wires (for doorphone and other connections):
Prepare wires of the appropriate specification. (→"Wire type and length")

Note:

- The illustrations in the supplied manual(s) may vary slightly from the actual product.

*1 VL-SV71/VL-SV72 models only

*2 VL-SV72/VL-MV72 models only

Precautions for installation

To avoid malfunction or communication disturbances, do not install the doorphone or the main monitor/extension monitor in the following locations:

- Places where vibration or any other kind of impact occurs.
- Places where echoing is frequent.
- Places near a high concentration of dust, hydrogen sulphide, ammonia, sulphur, or noxious fumes.

For the doorphone

- If a strong light is shining on the doorphone, the visitor's face may not be distinguishable. Do not place the doorphone in the following locations:
 - Where most of the background is the sky.
 - Where the background is a white wall, and direct sunlight will reflect off it.
 - Where direct sunlight will shine on the doorphone.
- Do not place the doorphone in locations where echoing occurs, as this will cause the doorphone to beep frequently.
- Make sure the rear of the doorphone is not subject to water.
- Depending on the installation location, condensation may form on the doorphone's lens cover. This may cause images to become obscured. Condensation will dissipate as the temperature rises.

For the main monitor/extension monitor

- Leave at least 20 cm of space above, below, and to the left and right sides of the main monitor/extension monitor. Do not install on a wall that is deeply recessed.
- Do not install the main monitor/extension monitor inside a wall.
- Be sure to install the main monitor/extension monitor more than 5 m away from the doorphone.
- In areas surrounded by a high electrical field, disturbances may occur in the main monitor's/extension monitor's image or sound.

Wire type and length

Wiring run	Wire type *1		
	Diameter		Length (Max.)
Doorphone – Main monitor – Extension monitor*2	ø 0.65 mm	22 AWG	100 m
	ø 1.0 mm	18 AWG	130 m
	ø 0.5 mm	CAT 5	50 m
Main monitor – Power supply unit	ø 0.65 mm	22 AWG	10 m
	ø 1.0 mm	18 AWG	20 m
Main monitor – Electric lock*3	ø 0.5 mm - ø 1.2 mm (24 AWG - 17 AWG)		According to the specifications of the connected device.
Main monitor – Connection device for option input (A contact)*3	ø 0.5 mm - ø 1.2 mm (24 AWG - 17 AWG)		According to the specifications of the connected device.
Main monitor – PBX	ø 0.65 mm	CAT 3 or 22 AWG	100 m

*1 Type: Single-pair cable with outer sheath (jacket)

Conductor: Copper solid

- A certified power supply wiring has to be used with this equipment. The relevant national installation and/or equipment regulations shall be considered. A certified power supply wiring not lighter than ordinary polyvinyl chloride flexible wiring according to IEC 60227 shall be used.

*2 When an extension monitor is used, make sure that the total wiring length from the doorphone to the main monitor and then to the extension monitor, is within about 100 m.

*3 When using an electric lock or a connection device for option input (A contact), select a device that meets the following guidelines:

- Electric lock connection terminal (S1/S2):
 - N/O dry closure contact
 - 30 V AC (1 A)/24 V DC (1 A) or lower
- Connection device for option input (A contact) terminal (IN1/IN2/IN3/IN4):
 - Input method: No-voltage contact
 - Open-circuit voltage between terminals: DC 7 V or less
 - Detection definite time: 0.1 second or more
 - Short-circuit between terminals: 5 mA or less
 - Resistance value: make: 500 Ω or less, break: 15 KΩ or more

■ Connecting an optional lobby station

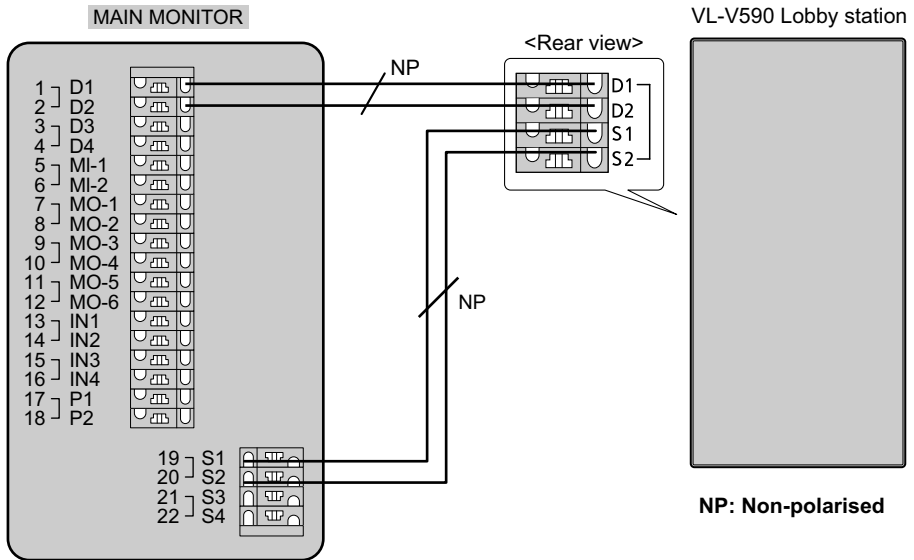

<Be sure to perform the following to ensure proper operation>

- Connecting an optional VL-V590 lobby station
 - Connect terminal D1/D2 on the main monitor with terminal D1/D2 on the lobby station.
 - Connect terminal S1/S2 on the main monitor with terminal S1/S2 on the lobby station.
 - After connecting to the main monitor, change the [Lobby connection] setting to [Connected devices] using the main monitor. (→Operating Instructions of the Video Intercom System.)
- Connection for VL-V900 and VL-V700 series Video Intercom System for Apartment Complexes
 - Connect terminal D1/D2 on the main monitor with terminal D1/D2 on the VL-V701 Distribution Box.

Note:

- For information about connections, refer to the documentation of the VL-V590 or VL-V900 and VL-V700 series.

Doorphone installation position

Installation position of the doorphone and camera range

Views when the camera is facing forwards at 0° (default).

- Example: Installation height is 1450 mm (standard position).

(Units: mm)

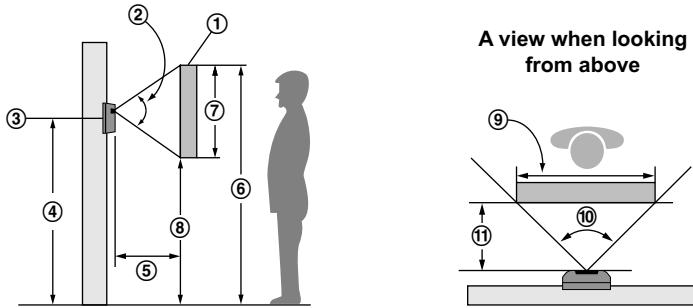

- ① Image range ② Approx. 66° ③ Centre of doorphone ④ Approx. 1450 ⑤ Approx. 500
 ⑥ Approx. 1810 ⑦ Approx. 650 ⑧ Approx. 1160 ⑨ Image range: Approx. 960 ⑩ Approx. 87°
 ⑪ Approx. 500

The camera angle can be adjusted using the camera angle control lever on the rear of the doorphone (step 3, "Installing the doorphone"), so that the image range can be changed.

Side view when the camera is installed lower than the standard position, and facing upwards at 15°.

- Example: Installation height is 1100 mm.

(Units: mm)

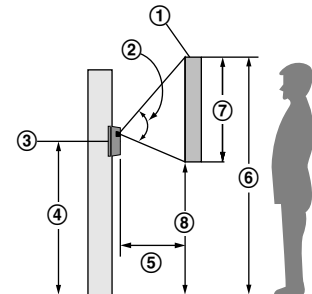

- ① Image range ② Approx. 66° ③ Centre of doorphone ④ Approx. 1100 ⑤ Approx. 500
 ⑥ Approx. 1690 ⑦ Approx. 710 ⑧ Approx. 980 ⑨ Image range: Approx. 1080 ⑩ Approx. 270
 ⑪ Approx. 810 ⑫ Approx. 87° ⑬ Approx. 500

*1 If the camera points 15° upwards, the left or right angle is less than 7°.

Note:

The measurements and angles are for reference purposes and may vary depending on the environment.

Top view when the camera is facing left or right at 15° *1.

- Example: Camera angle faces left 15°.

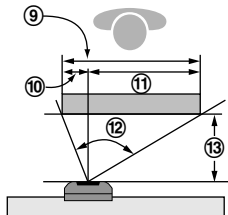

Installing the doorphone

Important:

- On the bottom surface of the doorphone and the mounting base, there are holes to allow water to drain. Do not cover them up when installing.
- When existing wiring (such as chime wires) is used:
 - It may contain AC voltage that may cause electric shock and/or damage the product.
 - Never use the following types of wiring. Consult a qualified technician/dealer.

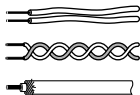

- See "Wire type and length" for information about wiring materials.

- 1 Remove the mounting base.
 - 1 Open the screw cover (1).

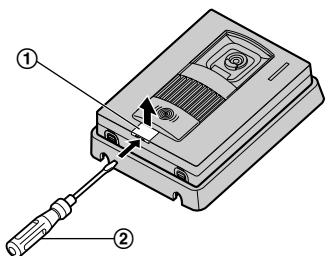

② ⊖ Screwdriver

- 2 Loosen the mounting screw (3).

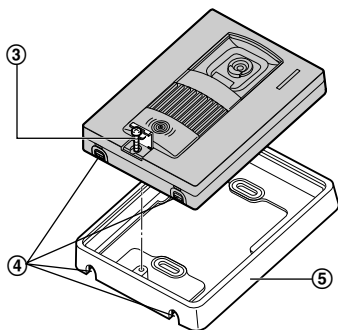

④ Water drain holes
⑤ Mounting base

- 2 Attach the mounting base (1) to the wall securely using the wood screws (2) (accessory).
 - Install the mounting base on a vertical flat wall.
 - Before drilling, refer to "Precautions for installation" for installation location.

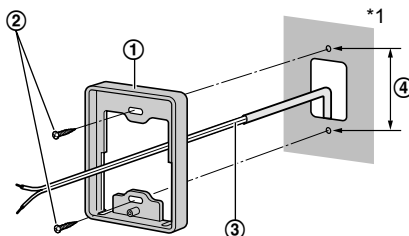

③ Wire (locally procured)

④ 83.5 mm

*1 To prevent dew condensation, fill a hole for wiring as much as possible.

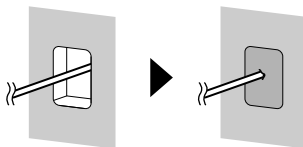

- 3 Adjust the camera angle using the camera angle control lever.

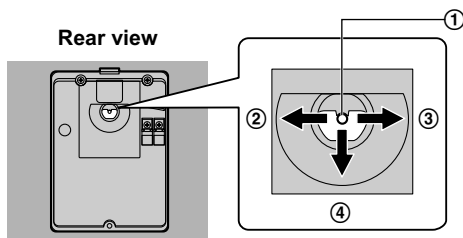

① Camera angle control lever

② Left (maximum 15°)

③ Right (maximum 15°)

④ Upwards (maximum 15°)

Examples of camera angle

Facing forwards

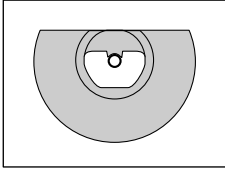

Facing upwards

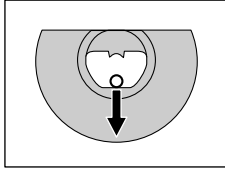

Facing right

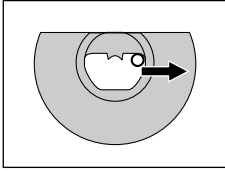

Facing upper right

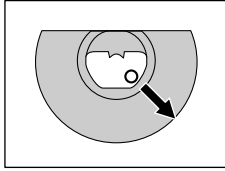

- The angle can also be adjusted to the left or upper left.

Important:

- When the camera angle is adjusted to the upper left or upper right, the image may be slightly distorted.

4 Connect the wire, then mount the doorphone to the mounting base.

① Unscrew the screws.

Push in the wire to the terminal connectors (non polar), then tightly fasten the screws (①).

- ① – Recommended torque: 0.5 N·m {5.1 kgf·cm}
- Maximum torque: 0.7 N·m {7.1 kgf·cm}

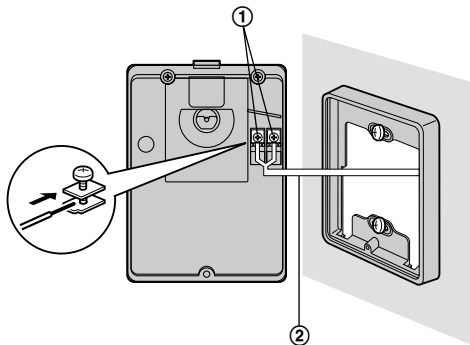

② Wire (connecting to the main monitor)

- ② Mount the doorphone to the mounting base. Fasten the screw, then close the screw cover (③).

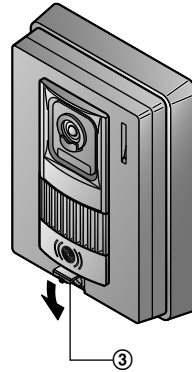

Installing the power supply unit (VL-SV72AZ, VL-MV72AZ models only)

About the installation location

- The AC cable plug is used as the main disconnect device. Ensure that the power outlet is installed near the product and is easily accessible.
- A readily accessible disconnect device shall be incorporated external to the equipment.
 - External disconnect device must be certified and have a creepage and clearance distance of 3 mm or more.

Precautions for wiring

- Make sure that the power supply unit is unplugged before performing any wiring work.
- Always connect AC or DC cables to the appropriate connector or connection terminal.
- To prevent the DC cable from disconnecting and to prevent electric shock, secure the DC cable using the cable binder (accessory) and attach the cable cover.

How to connect the AC cable and DC cable:

Connect the power supply unit (accessory), the AC cable (accessory), and a DC cable (locally procured).

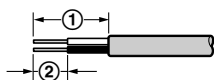

① 25 mm ② 7 mm

Front view

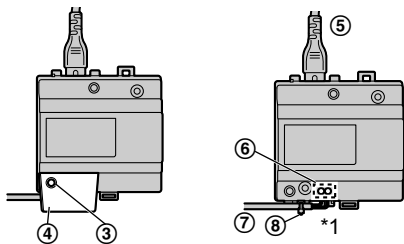

*1 Make sure that there are no bare wires exposed outside the product.

Power supply unit (with cable cover removed)

Top view

Bottom view

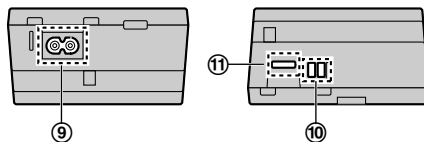

⑪ DC cable binder hole

- 1 Strip the DC cables as follows:
DC cable (①, ②)
- 2 Remove the screws (③) and then remove the cable cover (④).
- 3 Connect the AC cable (⑤) (accessory) to the AC IN connector (⑨) on the top of the power supply unit. Next, connect the DC cable (⑦) (locally procured) to the DC OUT terminal (⑩) on the bottom of the power supply unit, and then secure the wires by tightening the screws (⑥).
 - Recommended torque: 0.45 N·m {4.6 kgf·cm}

⚠ CAUTION
Insert the cables firmly all the way into the connector and terminals. If the cables are not inserted all the way, heat may be generated.

- 4 Use the cable binder (⑧) (accessory) to secure the DC cable (⑦) (double-coated area) to the power supply unit.
- 5 Make sure to replace the cable cover (④).

Wall mounting

Attach the power supply unit to the wall securely.

- ① Screws (accessory) × 2

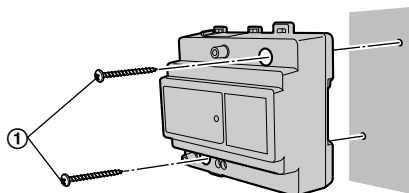

Attach to the DIN rail

Attach in the order described below so that hook (1) is positioned at the bottom.

- 1 Hang hook (2) on the DIN rail (3).
- 2 Pull and hold the lever down (4).
- 3 Secure hook (1) to the DIN rail (5).

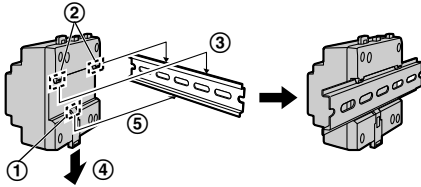

Main monitor/extension monitor installation position

About the installation position of the main monitor/extension monitor and mounting bracket

- Place the main monitor/extension monitor in a location that your eyes are the same height as the centre of the display.
- For the following reasons, leave at least 20 cm (1) of space above, below, and to the left and right sides of the main monitor/extension monitor:
 - To prevent malfunction and sound cutting out
 - To ensure to make sure the reset button (2) can be used (the reset button is on the bottom of the main monitor/extension monitor)

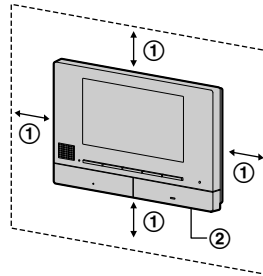

- After deciding where to install the main monitor/extension monitor, attach the mounting bracket in the location shown below.

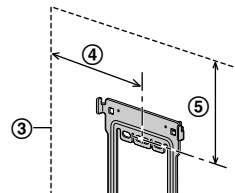

③ Main monitor/extension monitor installation position

④ 121.5 mm

⑤ 58 mm

Installing the main monitor/ extension monitor

- 1 Attach the mounting bracket (①) to the wall securely.
 - Install the mounting bracket on a vertical flat wall (②).

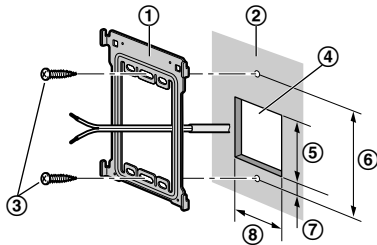

- ③ Screws (accessory)
- ④ Hole in wall ⑤ 60 mm ⑥ 83.5 mm
- ⑦ 7 mm ⑧ 50 mm

2 VL-SV71BX/CX/ML/SX/AZ and VL-MV71BX/ CX/ML/SX/AZ models:

Connect the wires.

- Connect the wires correctly according to "Wiring schematic diagram".

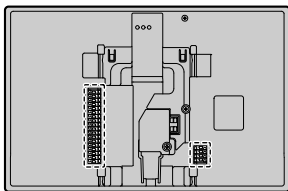

- **How to make wiring connections**
While pressing on the button (①) with a pointed object such as a screwdriver, insert the wire into the terminal connector (②). (To disconnect a wire, while pressing on the button (①), pull out the wire.)

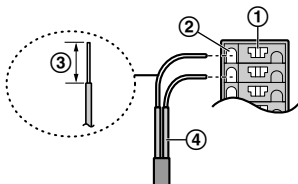

- ③ Bare wire at tip: 9 mm
- ④ Wiring from doorphone or other device

VL-SV72AZ and VL-MV72AZ models:

Connect the DC cable and wires.

- Connect the wires correctly according to "Wiring schematic diagram".

2-1 How to connect the DC cable

- 1 Remove screw A (①) and then remove the terminal cover.
- 2 While pressing on the button (②) with a pointed object such as a screwdriver, insert the wires of the DC cable into the terminal connectors (non-polar).
- 3 Make sure to replace the terminal cover.

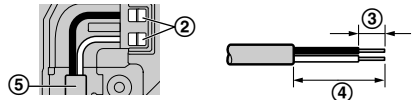
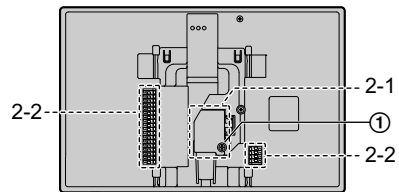

- Bare wire at tip: ③ 11 mm ④ 42 mm
- ⑤ Wiring from power supply unit

2-2 How to make wiring connections

While pressing on the button (⑥) with a pointed object such as a screwdriver, insert the wire into the terminal connector (⑦). (To disconnect a wire, pull out the wire while pressing on the button (⑥).)

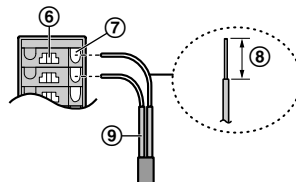

- ⑧ Bare wire at tip: 9mm
- ⑨ Wiring from doorphone

Important:

Do not connect the power cable.
(Damage may occur.)

- 3** Mount the main monitor/extension monitor to the mounting bracket.

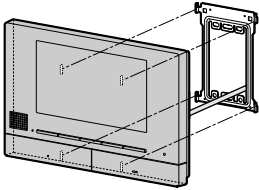

3-1 Line up the tab on the bottom of the bracket with the groove on the main monitor/extension monitor.

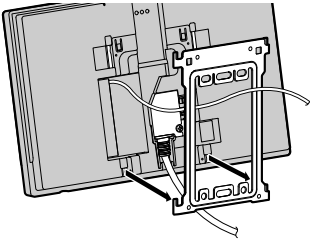

3-2 Line up the tab on the top of the bracket with the groove on the main monitor/extension monitor, and push the main monitor/extension monitor down until it is secure.

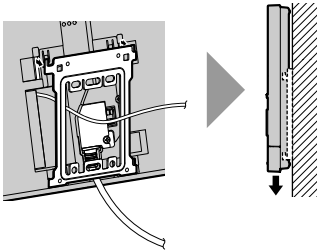

**Notes about electrical wiring (for VL-SV72/
VL-MV72 models)**

Make sure not to pinch the wires (as shown to the right) on the mounting bracket when installing.

- Do not forcibly attach to the mounting bracket.

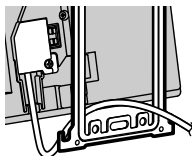

Panasonic Corporation

1006, Oaza Kadoma, Kadoma-shi, Osaka 571-8501, Japan
<http://www.panasonic.com>

© Panasonic Corporation 2017



PNQX8541ZA

PNQX8541ZA C0517MM0